



INSTRUMENTS

AirLink VOC Pro

Operator's Manual

Part Number: 71-0535

Revision: P8

Released: 1/11/24

WARNING

Read and understand this instruction manual before operating detector. Improper use of the detector could result in bodily harm or death.

Periodic calibration and maintenance of the detector is essential for proper operation and correct readings. Please calibrate and maintain this detector regularly! Frequency of calibration depends upon the type of use you have and the sensor types. For most applications, typical calibration frequencies are between 3 and 6 months but can be more often or less often based on your usage.

Product Warranty

RKI Instruments, Inc. warrants gas alarm equipment sold by us to be free from defects in materials, workmanship, and performance for a period of one year from date of shipment from RKI Instruments, Inc. Any parts found defective within that period will be repaired or replaced, at our option, free of charge. This warranty does not apply to those items which by their nature are subject to deterioration or consumption in normal service, and which must be cleaned, repaired, or replaced on a routine basis. Examples of such items are:

- Absorbent cartridges
- Fuses
- Pump diaphragms and valves
- Batteries
- Filter elements

Warranty is voided by abuse including mechanical damage, alteration, rough handling, or repair procedures not in accordance with the operator's manual. This warranty indicates the full extent of our liability, and we are not responsible for removal or replacement costs, local repair costs, transportation costs, or contingent expenses incurred without our prior approval.

THIS WARRANTY IS EXPRESSLY IN LIEU OF ANY AND ALL OTHER WARRANTIES AND REPRESENTATIONS, EXPRESSED OR IMPLIED, AND ALL OTHER OBLIGATIONS OR LIABILITIES ON THE PART OF RKI INSTRUMENTS, INC. INCLUDING BUT NOT LIMITED TO, THE WARRANTY OF MERCHANTABILITY OR FITNESS FOR A PARTICULAR PURPOSE. IN NO EVENT SHALL RKI INSTRUMENTS, INC. BE LIABLE FOR INDIRECT, INCIDENTAL, OR CONSEQUENTIAL LOSS OR DAMAGE OF ANY KIND CONNECTED WITH THE USE OF ITS PRODUCTS OR FAILURE OF ITS PRODUCTS TO FUNCTION OR OPERATE PROPERLY.

This warranty covers instruments and parts sold to users by authorized distributors, dealers, and representatives as appointed by RKI Instruments, Inc.

We do not assume indemnification for any accident or damage caused by the operation of this gas monitor, and our warranty is limited to the replacement of parts or our complete goods.

Caution Statements

WARNING: *EXPLOSION HAZARD - SUBSTITUTION OF COMPONENTS MAY IMPAIR SUITABILITY FOR CLASS I, DIVISION 1, or equivalent as stated in user manual.*

RISQUE D'EXPLOSION-LA SUBSTITUTION DE COMPOSANTS PEUT RENDRE CE MATERIEL INACCEPTABLE POUR LES EMBLEMES DE CLASSE I, DIVISION I.

CAUTION: *For safety reasons, this equipment must be operated and serviced by qualified personnel only. Read and understand the instruction manual completely before operating or servicing.*

ATTENTION: *POUR DES RAISONS DE SECURITE, CET ÉQUIPEMENT DOIT ETRE UTILISE ENTRETENU ET REPARER UNIQUEMENT PAR UN PERSONNEL QUALIFIE. ETUDIER LE MANUEL D' INSTRUCTIONS EN ENTIER AVANT D' UTILISER, D' ENTERETENIR OU DE RÉPARER L' ÉQUIPEMENT.*

CAUTION: *THIS AREA MUST BE FREE OF FLAMMABLE GASES DURING CALIBRATION.*

ATTENTION: *CETTE ZONE DOIT ETRE EXEMPTÉ DE GAZ INFLAMMABLES PENDANT L'ETALONNAGE.*

CAUTION: *TO PREVENT IGNITION OF EXPLOSIVE ATMOSPHERES, remove from explosive atmosphere BEFORE SERVICING.*

WARNING: *A conduit seal must be used within 18 inches of the enclosure wall to comply with the hazardous location rating of this product.*

Danger Statements

DANGER: The RKI Instruments Inc. AirLink VOC Pro is an ambient air Hazardous gas sensor assembly and only monitors in the immediate vicinity of the sensor housing. A site survey is required in order to determine the best placement and quantity of sensor assemblies. Improper installation can lead to an undetectable gas leak which could result in personal injury or loss of life.

Table of Contents

Overview	8
Specifications	9
External Description	11
Internal Description	12
Exploded Drawing	13
Remote-Mounted Kit	14
Installation	14
Mounting the AirLink VOC Pro	14
Remote-Mounted Kit Wiring	17
Wiring Power and 4-20 mA Output	18
Connecting RS-485 Modbus.....	20
Connecting Relays/Alarms	22
Connecting the Fault Terminal	23
Closing the Enclosure	25
Start Up	26
Operation	27
Normal Operating Mode.....	27
Manual Reset for Activated Latching Alarms.....	29
Magnetic Buttons	28
Powering the Device.....	29
Faults.....	30
Accessing Menus	30
Product Settings and Configuration	31
Entering the Product Settings and Configuration Menu.....	31
Alarm Test.....	32
Network ID.....	33

System Information	33
Zero/Calibration Timer Information	34
Unit Information	34
Background Setting	35
Latching and Auto Resetting Relay Settings	35
Relay Fail-Safe Setting	37
Fault Terminal Fail-Safe Setting	38
Calibration Method	39
Modbus Address Setting	39
Modbus Baud Setting	40
4-20 mA Offset Settings	41
Display Screen Contrast Setting	42
Return to Factory Default Settings	44
Reset Zero & Calibration Values	45
Operation Settings and Calibration	47
Zeroing the Sensor	47
Calibrating the Sensor (Manual Cal)	49
Calibrating the Sensor (Auto Cal)	50
Sensor Alarm Settings	53
Sensor Radio Address	55
Maintenance	56
Troubleshooting	56
Replacing the Desiccant	57
Cleaning the 10.0 eV or 10.6 eV PID Lamp	58
Replacing the PID Lamp	62
Replacing the PID Electrode Stack	65
Replacing the Sensor	68
Replacing the Fuse	70

Parts List72
Appendix A: 4-20 mA Signal74
Appendix B: Modbus Communications76
Appendix C: Modbus Register Map78

Overview

The RKI Instruments, Inc. AirLink VOC Pro explosion-proof ambient air hazardous gas detector is designed to detect a wide range of toxic gases in potentially hazardous environments. This product is QPS certified as Class I, Division 1, Groups B, C, and D and rated for Zone 1, Group IIB. The AirLink VOC Pro features non-intrusive magnetic switches that allow for complete system configuration, regular calibration, and product maintenance to be performed in the field, without opening the enclosure and breaking the seal of the enclosure, thereby compromising the explosion-proof rating of the device. Non-intrusive interface with the AirLink VOC Pro is made possible by use of the magnetic tool included in the purchase of the device.

In this manual, the instructions reference the use of push-buttons, located on the front panel of the device. In certain environments, the activation of the non-intrusive magnetic switches, through the use of the magnetic tool, will replace the directive of the button-press actions. To apply the magnetic tool, hold the tool to the side of the device enclosure adjacent to the push-button that you wish to activate. When the magnetic switch is toggled, an on-screen indicator will appear on the display screen, signifying that a connection was made.

The AirLink VOC Pro display screen will always show the present concentration of gas being detected by the sensor assembly.

This document is an operation manual containing diagrams and step-by-step instructions for the proper and safe installation, start-up, configuration, normal operation, and product maintenance of the AirLink VOC Pro.

NOTE: This document should be read in its entirety before the initial operation of the product.

Specifications

Table 1 lists specifications for the AirLink VOC Pro.

Table 1: Specifications

Lamp Type	Detection Range	Increment	Alarm Points (1 / 2 / 3 / 4)*
10.0 eV Lamp	0 - 10 ppm (parts per million)	0.01 ppm	1 / 1.5 / 1.5 / 10 ppm
	0 - 20 ppm		2 / 3 / 3 / 20 ppm
	0 - 50 ppm		5 / 7.5 / 7.5 / 50 ppm
	0 - 100 ppm	1 ppm	10 / 15 / 15 / 100 ppm
Low Range 10.6 eV Lamp	0 - 10.00 ppm (parts per million)	0.01 ppm	1 / 1.5 / 1.5 / 10 ppm
	0 - 20.00 ppm		2 / 3 / 3 / 20 ppm
	0 - 50.00 ppm		5 / 7.5 / 7.5 / 50 ppm
High Range 10.6 eV Lamp	0 - 100 ppm (parts per million)	1 ppm	10 / 15 / 15 / 100 ppm
	0 - 200 ppm		20 / 30 / 30 / 200 ppm
	0 - 500 ppm		50 / 75 / 75 / 500 ppm
	0 - 1,000 ppm		100 / 150 / 150 / 1,000 ppm
	0 - 2,000 ppm		200 / 300 / 300 / 2,000 ppm
11.7 eV Lamp	0 - 100 ppm (parts per million)	0.01 ppm	10 / 15 / 15 / 100 ppm

* Alarms are only programmable at a controller and do not affect operation of the AirLink VOC Pro.



Target Gas	Volatile organic compounds (VOCs) <ul style="list-style-type: none"> isobutylene calibration standard for 10.6 and 11.7 eV sensors benzene calibration standard for 10.0 eV sensor
Zero Suppression	0.1% of full scale
Sampling Method	Diffusion
Junction Box Hazardous Location Certification	Class I, Division 1, Groups B, C, D Ex db IIB Gb Class I, Zone 1, AEx db IIB Gb Tamb -40°C to +60°C 
Sensor Housing Hazardous Location Certification	Class I, Division 1, Groups B, C, D Ex db IIB Gb Tamb -40°C to +60°C 
Operating Voltage	12 - 35 VDC

Table 1: Specifications

Current Draw	250 mA max
Operating Temperature Range	-40°C to +54°C (-40°F to +129°F)
Humidity Range	0 - 98% relative humidity, non-condensing
Signal Output	<ul style="list-style-type: none">• 4 to 20 mA (3-wire)• RS-485 Modbus RTU• Wireless radio
Max Cable Length for Remote-Mounted Antenna	<ul style="list-style-type: none">• 100 feet
Relay Contact Ratings	<ul style="list-style-type: none">• 3A at 24 VDC, 115 VAC, and 250 VAC• each relay terminal protected by a 4A fuse
Enclosure Material	Aluminum
Sensor Housing Material	303 Stainless steel
Max Cable Length for Remote-Mounted Sensor Kit	35 feet
Dimensions	5.5" D x 6" W x 7" H
Weight	6 lbs.
Standard Accessories	Magnet

WARNING: *When using the AirLink VOC Pro, you must follow the instructions and warnings in this manual to assure proper and safe operation of the AirLink VOC Pro and to minimize the risk of personal injury. Be sure to maintain and periodically calibrate the AirLink VOC Pro as described in this manual.*

External Description

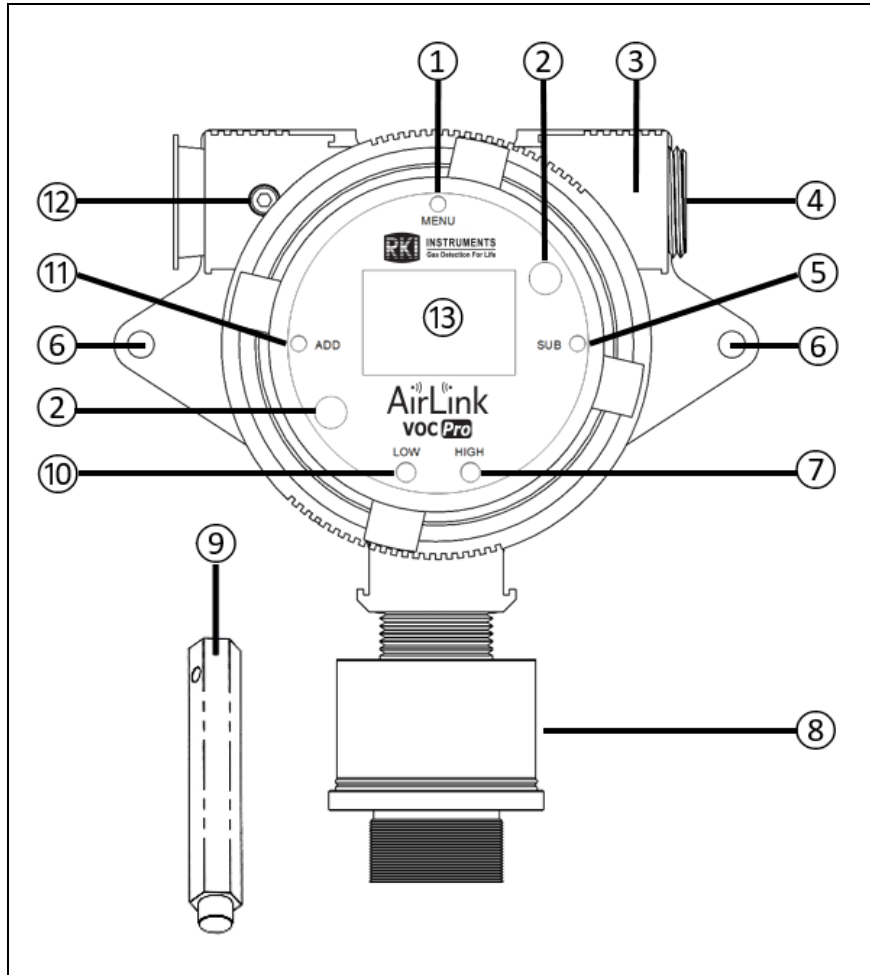

Figure 1: AirLink VOC Pro External Component Location

1	MENU button
2	Front panel thumbscrew
3	Enclosure
4	Explosion-proof plug
5	SUB button
6	Mounting hole
7	Alarm 2 LED

8	Sensor housing assembly
9	Magnetic tool
10	Alarm 1 LED
11	ADD button
12	Enclosure lid locking screw
13	Display screen

NOTE: The AirLink VOC Pro's conduit hubs are 3/4 NPT.

Internal Description

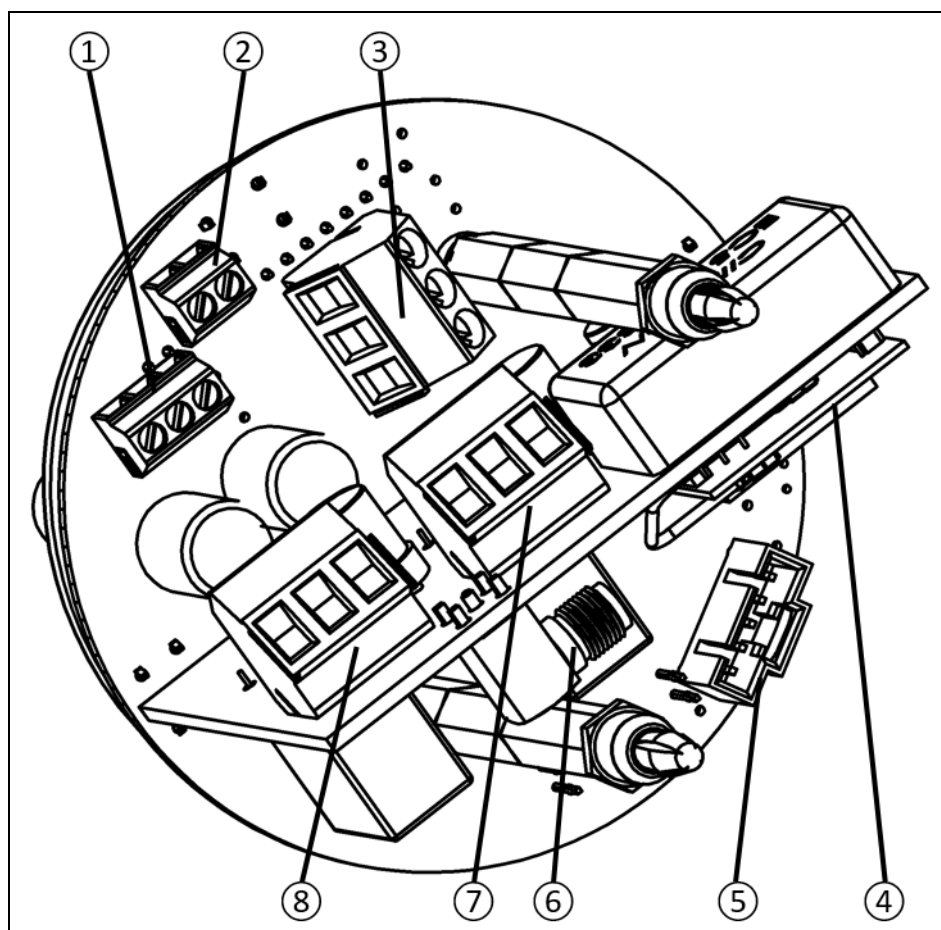

Figure 2: Internal Component Location

1	RS-485 Modbus terminal block
2	Fault terminal block
3	Power input/4-20 mA output terminal block
4	Radio module

5	Sensor housing socket
6	Antenna fitting connector
7	Relay 1 terminal block (if relays installed)
8	Relay 2 terminal block (if relays installed)

Exploded Drawing

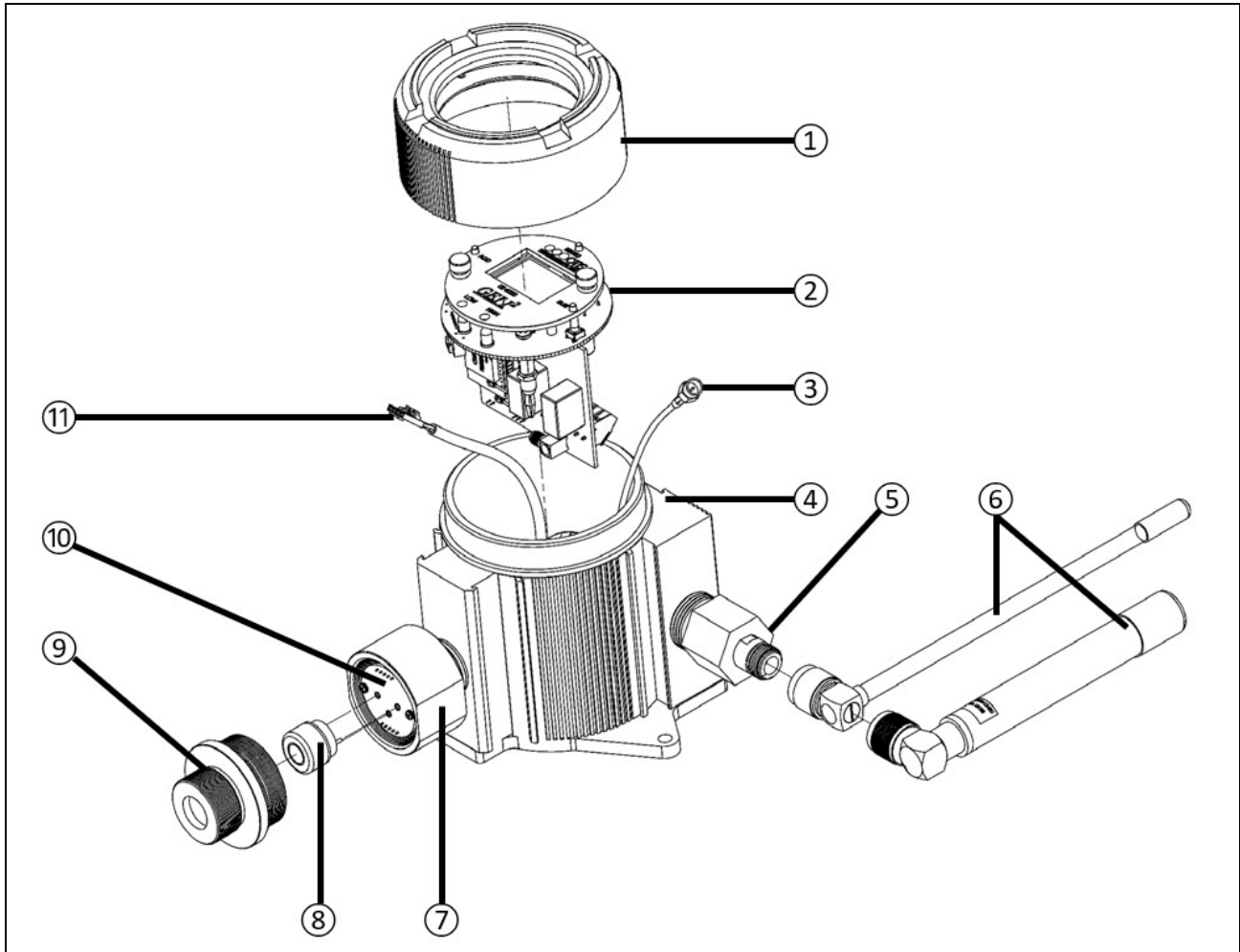

Figure 3: Exploded Diagram

1	Enclosure lid
2	Internal system
3	Antenna fitting plug
4	Enclosure body
5	Antenna fitting
6	900 MHz or 2.4 GHz antenna

7	Sensor housing base
8	Sensor element
9	Sensor housing cap with flame arrestor
10	Analog sensor board
11	Sensor housing plug

Remote-Mounted Kit

A remote-mounted sensor kit can be ordered if the sensor needs to be somewhere that is not conveniently accessible for viewing the display screen.

The kit includes a second junction box on a cable with a cable bushing/cable gland. The cable can be ordered in 1-foot increments with a maximum of 35 feet.

The cable and cable bushing/cable gland are not explosion-proof. If the assembly is installed in a classified location, the cable bushing must be removed and replaced with explosion-proof conduit. You must meet local electrical codes and use appropriate construction technique to maintain the explosion-proof classification of the assembly.

Installation

This section describes procedures to mount the AirLink VOC Pro in the monitoring environment and wire the AirLink VOC Pro.

NOTE: Radio connections between AirLink sensors and monitors must either all be routed through a repeater or all go straight to the monitor.

Mounting the AirLink VOC Pro

1. Consider the following when you select the mounting site:
 - Select a site where the AirLink VOC Pro is not likely to be bumped or disturbed. Make sure there is sufficient room to perform start-up, maintenance, and calibration procedures.
 - Select a site that is representative of the monitoring environment and where the target gas is likely to accumulate or where it is most likely to leak. The AirLink VOC Pro should not be installed near an entrance, air intake, or exhaust point.
 - The sensor must point down.
 - Avoid installing the AirLink VOC Pro in a location where airborne particles could cover or coat the sensor.

NOTE: These guidelines are **ONLY** intended as a general directive for the placement of the AirLink VOC Pro. This information should **NOT** serve as a complete list when considering all potential parameters for the proper location of the unit. It is **STRONGLY** advised that a third party Certified Industrial Hygienist, or other Certified Safety Professional, conduct a site survey and annotate the location and quantity of detection devices that should be installed for **EVERY** installation of **EVERY** site.

2. Select a mounting location and installation hardware. Mounting to a concrete or steel structure is recommended to minimize vibration and moisture. Use a maximum 1/4"-20 bolt or 1/4" diameter screw, flat washers, Grade 5 material, and corrosion protection like paint, galvanization, or zinc plating.

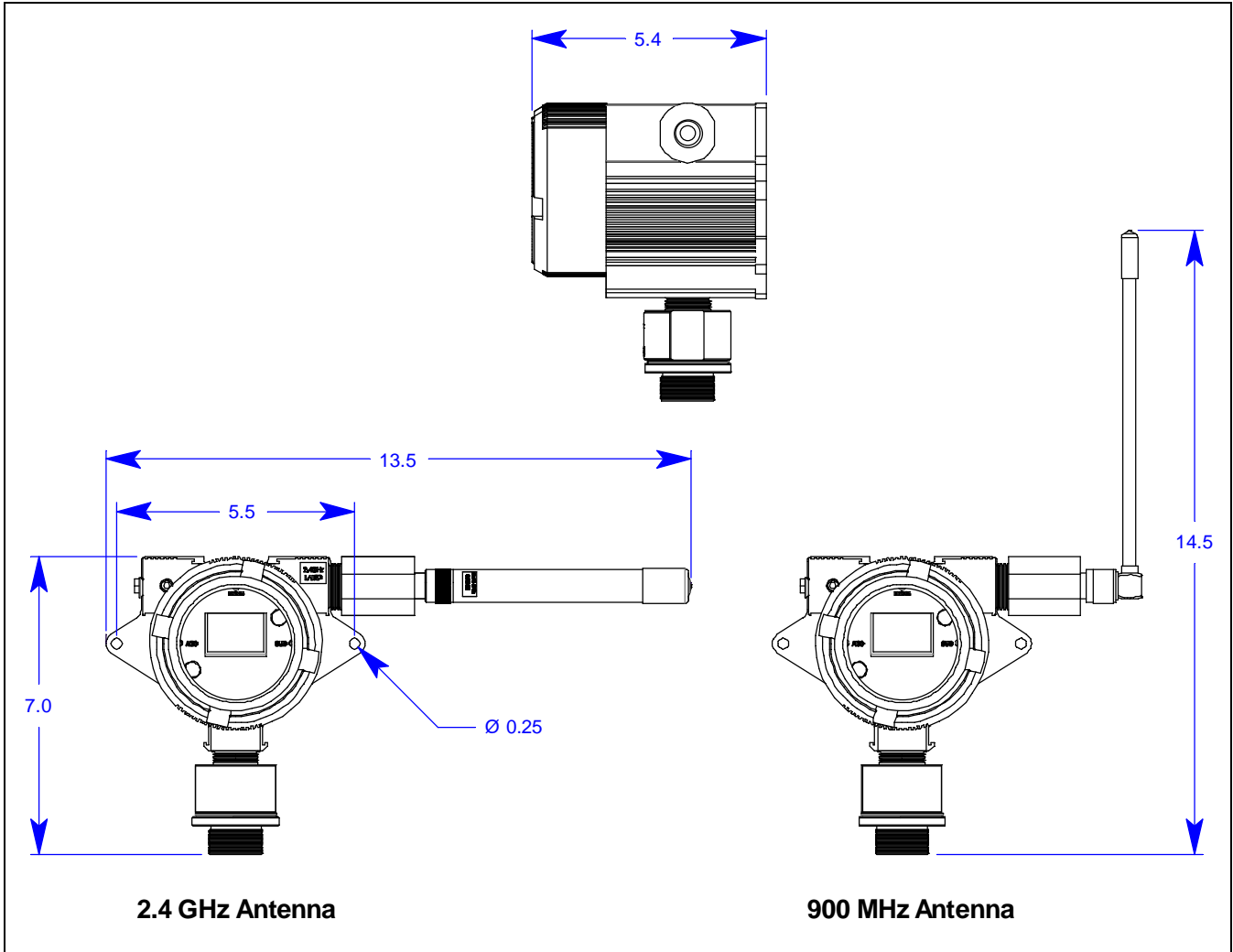

Figure 4: AirLink VOC Pro Dimensions

3. For a remote-mounted kit, install the detector junction box at the monitoring environment using techniques appropriate for the mounting area's classification and for the local electrical code. The cable and cable bushing/cable gland sent with the assembly are not explosion-proof.

WARNING: *If installed in a classified area, use appropriate construction technique to maintain the explosion-proof classification of the assembly.*

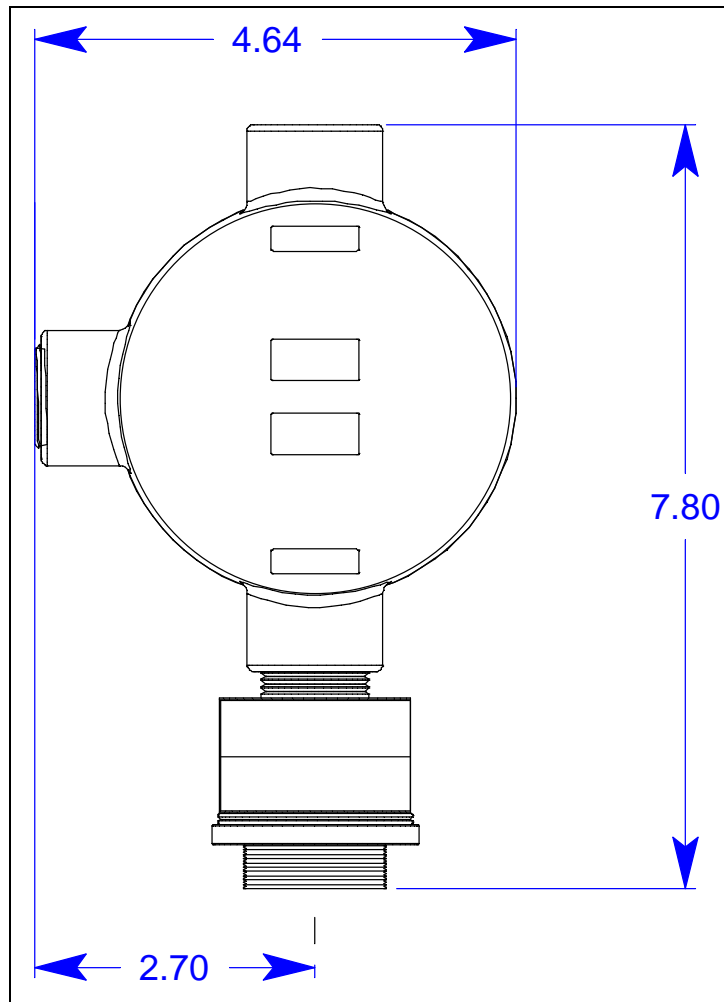

Figure 5: Remote-Mounted Kit's Detector Junction Box Dimensions

Remote-Mounted Kit Wiring

The remote-mounted kit generally comes prewired but if it becomes disconnected, follow these steps to reconnect it.

CAUTION: *The internal components can be static sensitive. Use caution when opening the enclosure and handling internal components.*

CAUTION: *Make sure the power source is off before beginning the wiring procedure.*

CAUTION: ***DO NOT** use any metal objects or tools to remove the terminal board from the internal system.*

1. Unscrew each enclosure lid and set it aside.
2. At the amplifier junction box, grab the thumbscrews and gently lift the internal system out of the enclosure. It can rest on the edge of the enclosure.
3. One end of the cable has a connector and the other has ferruled wires.
4. Feed the connector end of the cable through a 3/4 NPT conduit hub at the amplifier junction box.

WARNING: *If installed in a classified area, use appropriate construction technique to maintain the explosion-proof classification of the assembly.*

5. Plug the connector into the sensor connector socket at the amplifier junction box.
6. Feed the ferruled-wire end of the cable through a 3/4 NPT conduit hub at the detector junction box.

WARNING: *If installed in a classified area, use appropriate construction technique to maintain the explosion-proof classification of the assembly.*

7. Connect the ferruled wires to the color-coded terminals in the detector junction box.
8. Secure the detector junction box's enclosure lid back onto the enclosure.

Wiring Power and 4-20 mA Output

The AirLink VOC Pro has several basic wiring configurations, dependent upon the desired usage and functionality intended by the end-user. All AirLink VOC Pro units require +12 to +35 Volts of wired DC power to operate. Data communication from the device, through either the 4-20 output or the RS-485 Modbus connection, to an external location are optional.

CAUTION: *The internal components can be static sensitive. Use caution when opening the enclosure and handling internal components.*

CAUTION: *Make sure the power source is off before beginning the wiring procedure.*

CAUTION: ***DO NOT** use any metal objects or tools to remove the terminal board from the internal system.*

Table 2: AirLink VOC Pro Terminal Block Wire Gauges

Terminal Block	Wire Gauge
Power terminal	Min: 26 AWG
Relay 1 & 2 terminal	Max: 14 AWG
Modbus terminal	Min: 26 AWG
Fault terminal	Max: 16 AWG

1. Unscrew the enclosure lid and set it aside.
2. Grab the thumbscrews and gently lift the internal system out of the enclosure. It can rest on the edge of the enclosure.

NOTE: Disconnecting the sensor connector plug from the sensor housing will allow for the complete removal of the internal system from the device enclosure. Disconnecting the internal system may provide ease in accessing the control board terminals for wiring. Reconnect the sensor connector plug before reinstalling the internal system.

WARNING: *Use appropriate construction technique to maintain the explosion-proof classification of the assembly.*

3. Feed the power and 4-20 mA signal wires through the AirLink VOC Pro's 3/4 NPT power hub and into the enclosure.

NOTE: Wiring power to the device is the **ONLY** requirement for the AirLink VOC Pro to operate. With power, the unit will function normally, indicating the presence of toxic gas at the sensor and providing the gas level reading on the display screen. To utilize the added functionality of the device, additional wiring is necessary. If a controller is not used, the AirLink VOC Pro can be powered from any +12 to +35 VDC power supply that is capable of supplying at least 250 mA.

4. Locate the power terminal block on the control board and complete the following (see Figure 6).
 - Connect the power (GRAY) wire to the **VDC +** terminal.
 - Connect the ground (BLACK) wire to the **VDC -** terminal.
 - Connect the signal (GREEN) wire to the **4-20 mA (S)** terminal.

CAUTION: *If shielded cable is used, leave the cable shield's drain wire disconnected and insulated at the AirLink VOC Pro. You will connect the opposite end of the cable's drain wire to the controller's chassis (earth) ground.*

5. Route the cable or wires leading from the AirLink VOC Pro through one of the conduit hubs at the controller housing.

CAUTION: *Do not route power and AirLink VOC Pro wiring through the same controller conduit hub. The power cable may disrupt the transmission of the AirLink VOC Pro signal to the controller.*

6. Connect the wires to the applicable detector terminal strip at the controller as shown in Figure 6.

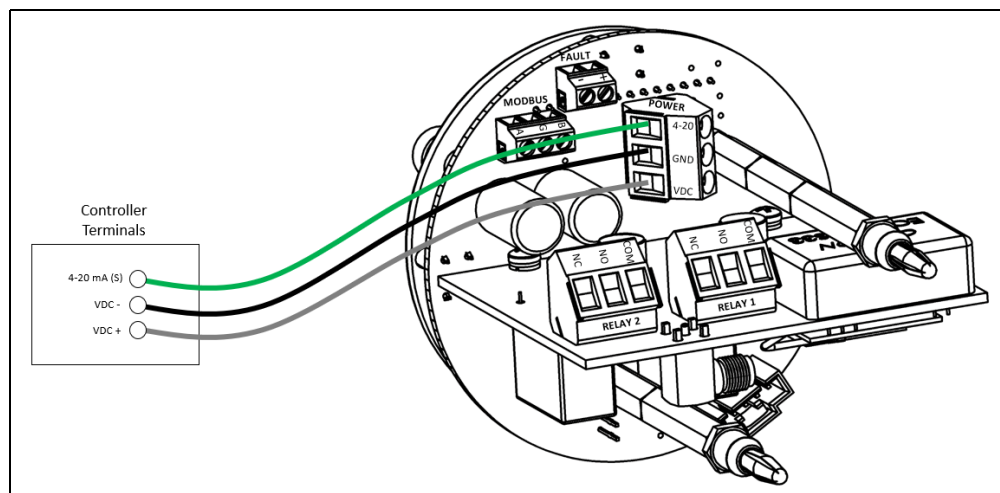

Figure 6: Wiring Power and Signal Wiring

7. If shielded cable is used, connect the cable's drain wire to an available chassis (earth) ground at the controller. RKI controllers typically have a ground stud that can be used to ground the cable's drain wire.

Connecting RS-485 Modbus

The AirLink VOC Pro supports Modbus RTU over a RS-485 link.

Table 3: T3A Terminal Block Wire Gauges

Terminal Block	Wire Gauge
Power terminal	Min: 26 AWG
Relay 1 & 2 terminal	Max: 14 AWG
Modbus terminal	Min: 26 AWG
Fault terminal	Max: 16 AWG

1. If necessary, unscrew the enclosure lid and pull the internal system out by the thumbscrews.

CAUTION: *Be sure power to the AirLink VOC Pro is off before pulling out the internal system.*

2. Feed the RS-485 cable through the 3/4 NPT power hub and into the enclosure.

WARNING: *Use appropriate construction technique to maintain the explosion-proof classification of the assembly.*

3. Connect the RS-485 B (BROWN) wire to the **B** terminal.
4. Connect the ground (BLACK) wire to the **GND** terminal.
5. Connect the RS-485 A (YELLOW) wire to the **A** terminal.

6. Feed the RS-485 cable through the power hub and into the controller and wire them to the correct terminals as shown below.

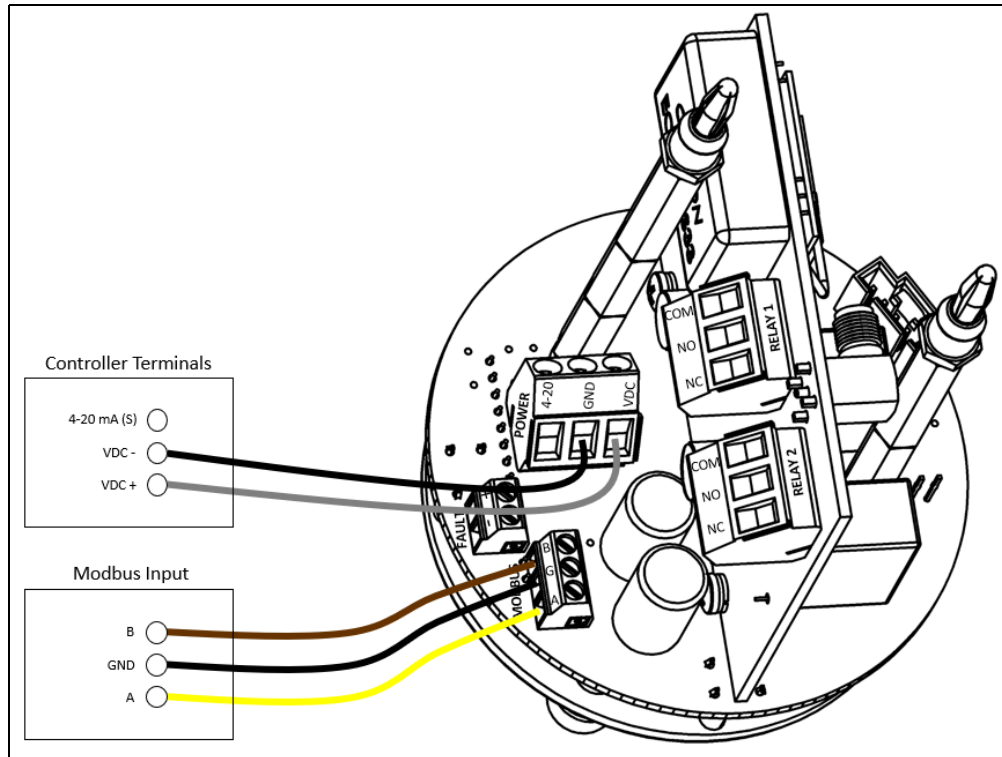

Figure 7: Modbus Wiring

NOTE: If an RKI controller is not used, the AirLink VOC Pro can be connected to a Programmable Logic Controller (PLC) for RS-485 Modbus data communications. For integration and setup, refer to the Modbus Register Map found in Appendix C of this manual.

Connecting Relays/Alarms

The AirLink VOC Pro relays are commonly used to power and control external alarming devices, such as alarm lights (visual) and horns (audio).

NOTE: Relays are protected by replaceable 4A fuses.

Table 4: T3A Terminal Block Wire Gauges

Terminal Block	Wire Gauge
Power terminal	Min: 26 AWG
Relay 1 & 2 terminal	Max: 14 AWG
Modbus terminal	Min: 26 AWG
Fault terminal	Max: 16 AWG

1. If necessary, unscrew the enclosure lid and pull the internal system out by the thumbscrews.

CAUTION: *Be sure power to the AirLink VOC Pro is off before pulling out the internal system.*

2. Feed the relay/alarm wiring through the 3/4 NPT power hub and into the enclosure.
3. Locate the relay terminal blocks on the radio/relay board.

WARNING: *Use appropriate construction technique to maintain the explosion-proof classification of the assembly.*

4. Connect the alarm device's power (RED) terminal to the **NO** or **NC** terminal on the relay terminal block.

NOTE: It is recommended that the relay connections are wired as normally-open (NO). However, normally-closed (NC) wiring configurations provide an inherent fail-safe and may be preferred.

5. Connect the alarm device's ground terminal (GREEN) to an external power source's “-” terminal.

- Connect the external power source's "+" terminal (GRAY) to the **COM** terminal on the relay terminal block.

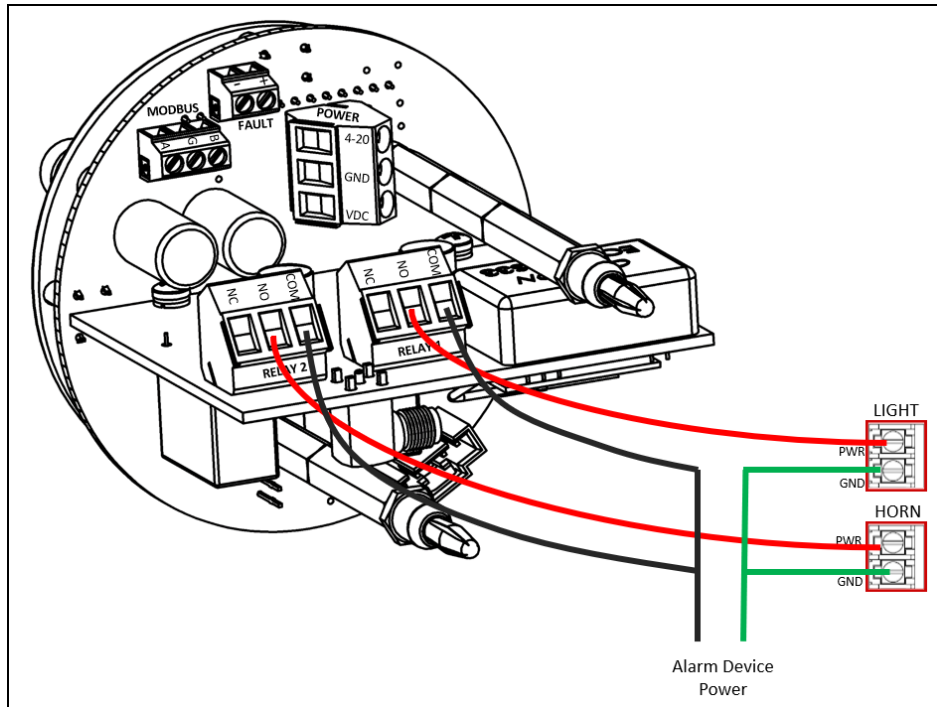

Figure 8: Relay Wiring

Connecting the Fault Terminal

The fault terminal is used to provide indication of a device failure (for reasons listed on page 56 or for a power failure). The fault terminal is shipped configured as a normally-closed (NC), or fail-safe, configuration, terminating power to the external fault device when prompted. Changing this behavior is detailed on page 37.

Unlike the optional relay terminals, the fault terminal is a wet-contact, requiring only the power and ground wires of the external fault device to be wired during installation. During normal operation, the fault terminal provides a maximum of 500 mA at the same voltage that is provided to the power terminal block.

Table 5: T3A Terminal Block Wire Gauges

Terminal Block	Wire Gauge
Power terminal	Min: 26 AWG
Relay 1 & 2 terminal	Max: 14 AWG
Modbus terminal	Min: 26 AWG
Fault terminal	Max: 16 AWG

- If necessary, unscrew the enclosure lid and pull the internal system out by the thumbscrews.

CAUTION: Be sure power to the AirLink VOC Pro is off before pulling out the internal system.

2. Locate the power (RED) and ground (BLACK) wires on the alarming device.

WARNING: Use appropriate construction technique to maintain the explosion-proof classification of the assembly.

3. Feed the alarming device's wires through the 3/4 NPT power hub and into the enclosure.
4. Locate the fault terminal block on the control board.
5. Connect the external fault device power (RED) wire to the + terminal.
6. Connect the external fault device ground (BLACK) wire to the - terminal.

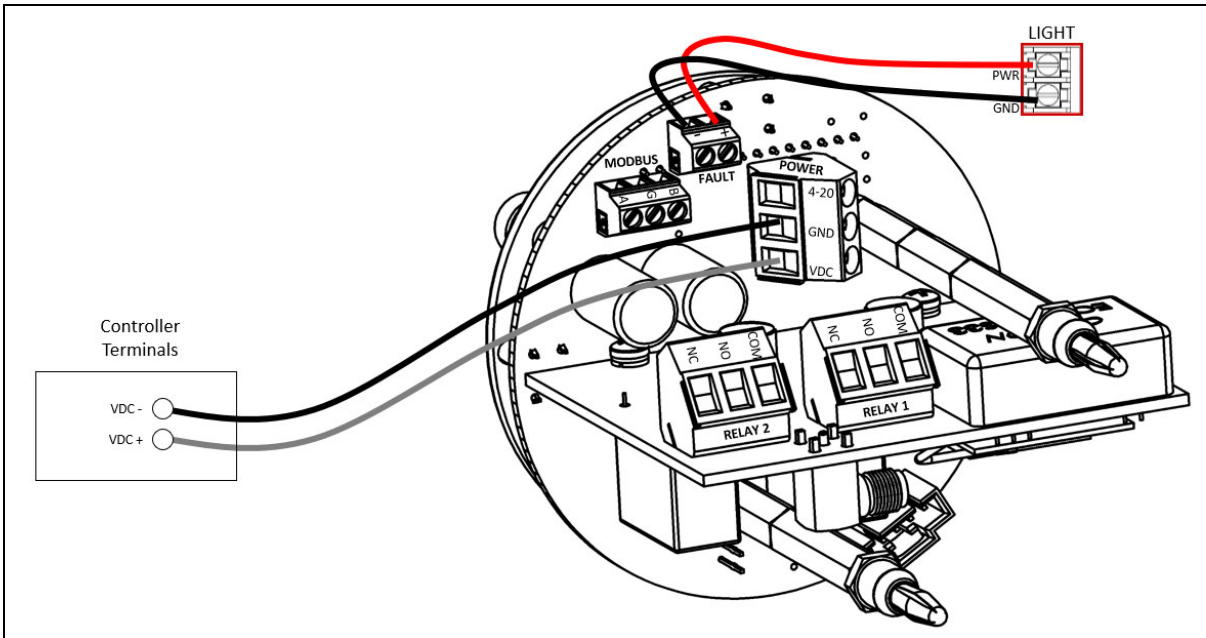

Figure 9: Fault Terminal Wiring

Closing the Enclosure

1. Place the internal system back into the enclosure, matching each mounting post to its corresponding eyelet anchored within the base of the enclosure.
2. Using the thumbscrews, gently push to seat the internal system into the mounting posts.

NOTE: The thumbscrews on the AirLink VOC Pro function **ONLY** as thumb-holds for ease in removal of the internal system from the base of the enclosure. Do **NOT** attempt to loosen or tighten the thumbscrews when opening or closing the enclosure.

3. Verify that the sealing ring, seated at the threaded opening of the device enclosure, is correctly in place.
4. Secure the enclosure lid back onto the enclosure.

WARNING: *When securing the lid onto the device, tighten the enclosure lid by hand ONLY. Overtightening of the lid by use of hand-tools could result in damage to the O-ring, potentially compromising the moisture seal, resulting in an unsafe environment.*

Start Up

This section describes procedures to start up the AirLink VOC Pro and place the AirLink VOC Pro into normal operation.

1. Complete the installation procedures described earlier in this manual.
2. Verify that the power wiring is correct and secure.
3. Turn on the power source.
4. Verify that the controller is on and operating properly. Refer to the controller operator's manual.
5. The AirLink VOC Pro automatically powers on and enters a 1-minute startup period.

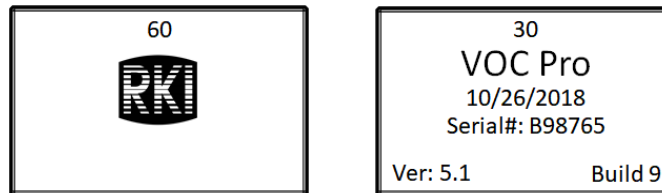

6. At the end of the startup, the AirLink VOC Pro is in Normal Operating Mode.

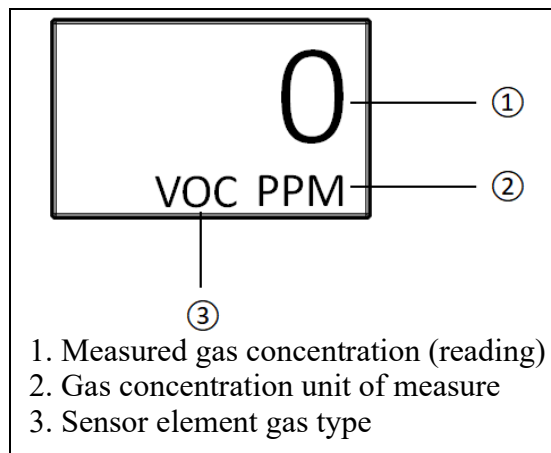

7. Allow the AirLink VOC Pro to warmup for 10 minutes.
8. The AirLink VOC Pro is factory-calibrated before shipping from RKI. If a full calibration is desired at startup, see page 47.

NOTE: The user interface will be slow to respond until the AirLink VOC Pro establishes a connection with a controller.

Operation

WARNING: Do not remove the sensor housing cap or enclosure lid while the circuits are energized unless the area is determined to be non-hazardous. Keep the sensor housing cap and enclosure lid tightly closed during operation.

Normal Operating Mode

While in Normal Operating Mode, the AirLink VOC Pro continuously samples the air and updates the measured concentration of the target gas on the display screen. The display, when in Normal Operating Mode, appears as shown below.

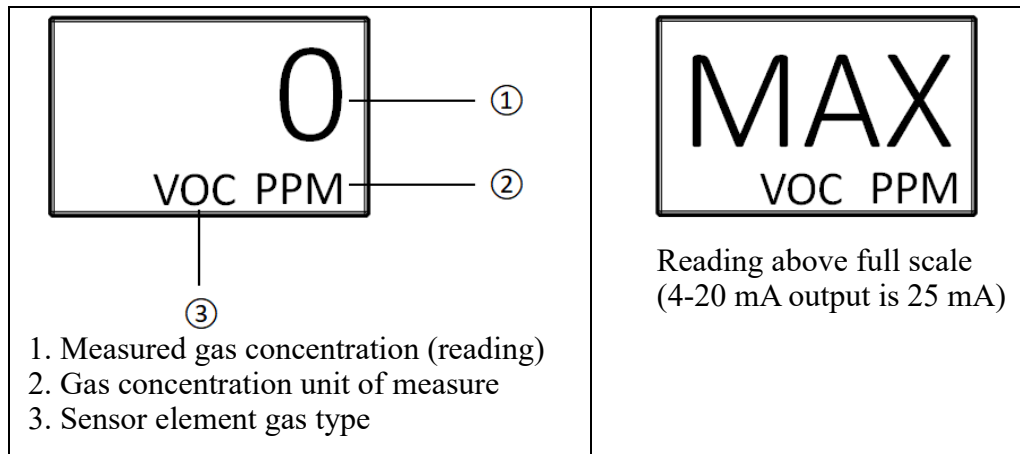

The gas reading is sent back to the controller in 1-minute intervals when the reading is below the background setting (see page 35). When the reading surpasses the background setting, the reading is sent back to the controller in 5-second intervals.

NOTE: The user interface will be slow to respond until the AirLink VOC Pro establishes a connection with a controller.

Manual Reset for Activated Latching Alarms

Relay alarms set to latching will not deactivate until the alarms are manually reset at the device. This includes Alarm 1 and Alarm 2 indicator LEDs and optional wired relays. When latching alarms have been activated, refer to the following instructions for how to manually deactivate the alarms on your device:

1. Verify that the gas level reading is below the alarm level setting.
2. Press the MENU button to deactivate latching alarm(s).

NOTE: The gas level reading **MUST** be below the alarm level setting before the alarm can be deactivated. Press the MENU button **ONLY** once to deactivate the latching alarm(s). Pressing the MENU button more than once will activate and open the Operation Settings menu. The alarms will **NOT** activate, even in the presence of gas, until you have exited the menu mode for approximately 1 minute.

Magnetic Buttons

Use the provided magnet to actuate the AirLink VOC Pro's buttons without having to remove the junction box's lid. Touch the magnet to the outer edge of the junction box lid near the button you want to actuate. Tapping the junction box is the same as pressing and releasing the button. Holding the magnet against the junction box is the same as pressing and holding the button.

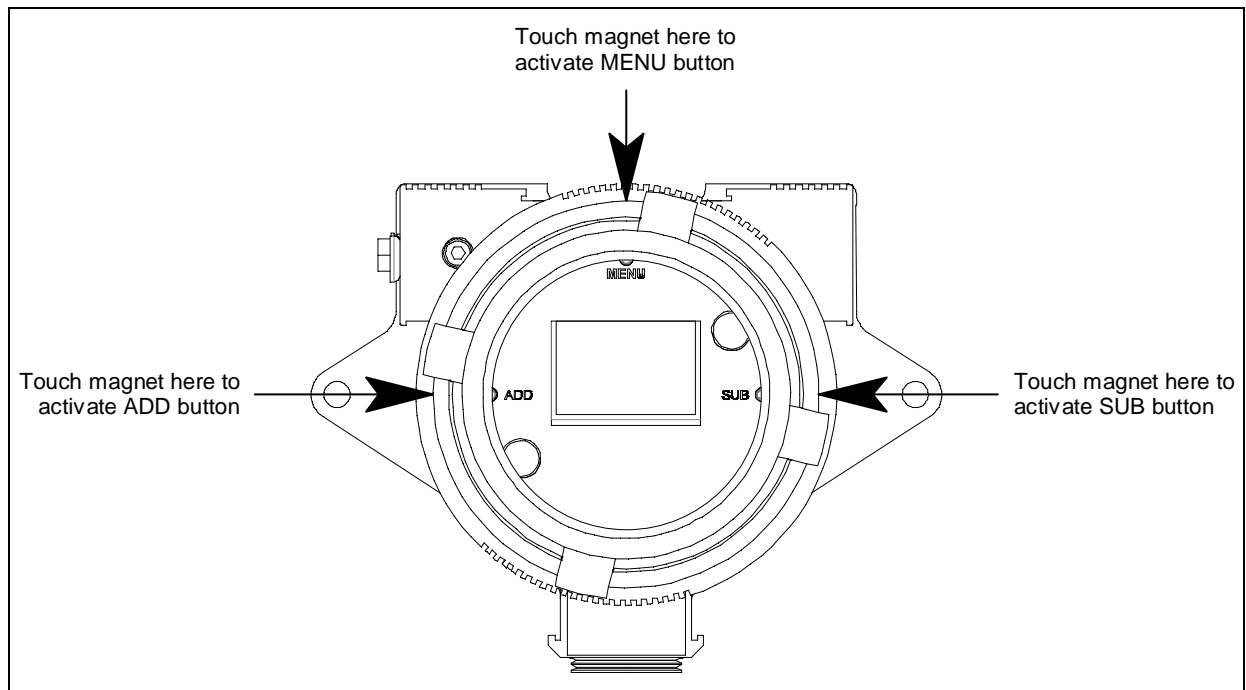

Powering the Device

When power is first applied to the VOC Pro, the unit automatically powers on and begins the startup sequence. The directions below describe how to power off and power on the VOC Pro once power has been applied.

Powering Off

Powering off the device stops the operation of the unit. The Product Settings and Configuration, as well as the operation settings, including the zero and calibration of the sensor, will be unaffected.

1. Press and hold the SUB button for approximately 6 seconds, until “OFF” shows on the display screen.

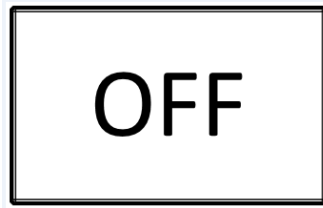

2. The display screen will continue to show “OFF” for the duration of time that the unit is powered off, as long as uninterrupted power is supplied to the unit.

Powering On

Powering on the device begins the operation of the unit, automatically initiating the system start-up cycle and 1-minute warmup period. The AirLink VOC Pro will be in normal operating mode at the completion of the system start-up.

To turn the AirLink VOC Pro on, press the ADD button once.

Manual Reset for Activated Latching Alarms

Relay alarms set to latching will not deactivate until the alarms are manually reset at the device. This includes Alarm 1 and Alarm 2 indicator LEDs and optional wired relays. When latching alarms have been activated, refer to the following instructions for how to manually deactivate the alarms on your device:

1. Verify that the gas level reading is below the alarm level setting.
2. Press the MENU button to deactivate latching alarm(s).

NOTE: The gas level reading **MUST** be below the alarm level setting before the alarm can be deactivated. Press the MENU button **ONLY** once to deactivate the latching alarm(s). Pressing the MENU button more than once will activate and open the Operation Settings menu. The alarms will **NOT** activate, even in the presence of gas, until you have exited the menu mode for approximately 1 minute.

Faults

In the event of a device failure, the unit will alternate between the normal operating screen and a fault screen on the display, in 5 second intervals, until the fault has been cleared, or is corrected. The fault code, located in the bottom-left corner of the display, appears on both screens. The unit continuously registers that the system is in fault. When the fault is corrected, the unit will return to normal operating mode.

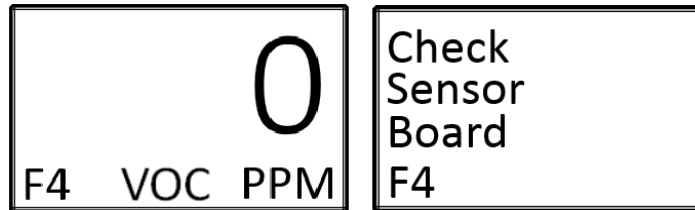

For a list of the fault codes and warning symbols of the AirLink VOC Pro, and their associated meaning, see page 56.

Accessing Menus

Both system menus are accessible from Normal Operating Mode.

- To access the Product Settings and Configuration menu, **press and hold** the MENU button, for approximately 6 seconds, until the menu is activated and open on the display screen.
- To access the Operation Settings menu from Normal Operating Mode, press and release the MENU button once and the menu will open and show on the display.

NOTE: After 5 minutes of no interaction with the device, the unit will automatically return to normal operating mode.

Product Settings and Configuration

The Product Settings and Configuration menu allows the end-user to tailor the device settings to meet their required specifications and/or site conditions.

The AirLink VOC Pro continues monitoring for gas while in the Product Settings and Configuration menu.

The Product Settings and Configuration menu consists of the following screens:

- Alarm Test (see page 32)
- Network ID (see page 33)
- System Information (see page 33)
- Zero/Calibration Timers (see page 34)
- Unit Info (see page 34)
- Background Setting (see page 35)
- Relay 1: Latching/Auto Resetting Setting (see page 35)
- Relay 2: Latching/Auto Resetting Setting (see page 36)
- Relay 1: Fail-Safe Setting (see page 37)
- Relay 2: Fail-Safe Setting (see page 38)
- Fault Terminal Fail-Safe Setting (see page 38)
- Calibration Method (see page 39)
- RS-485 Modbus Address Setting (see page 39)
- RS-485 Modbus Baud Setting (see page 40)
- 4-20 mA Offset Settings: Zero Offset Setting, Full-Scale Offset Setting (see page 41)
- Display Screen Contrast Setting (see page 42)
- Return to Factory Default Settings (see page 44)
- Reset Zero and Calibration Values Only (see page 45)

Entering the Product Settings and Configuration Menu

While the device is in normal operating mode, **press and hold** the MENU button for approximately 6 seconds until the Product Settings and Configuration menu is activated and open on the display screen.

NOTE: After 5 minutes of no interaction with the device, the unit will automatically return to normal operating mode.

NOTE: The alarms will NOT activate, even in the presence of gas, until you have been out of the Product Settings and Configuration menu for 1 minute.

Alarm Test

The alarm test simulates a gas level reading. The alarm test is used to ensure the proper functionality of the relay settings on the controller. The test can also be used to simulate emergency/safety drills onsite.

NOTE: Triggering AirLink VOC Pro relays will also simulate Alarm 1 and Alarm 2 relays at the controller. Controllers cannot distinguish between real and simulated data received. When the controller relays are triggered, alarm devices will perform as intended, initiating emergency procedures as if a harmful or toxic gas was actually present. To prevent this from occurring, set the controller to calibration mode before performing the alarm test. Calibration mode allows data transmission without relay activation.

It is recommended that an alarm test be conducted EVERY 30 days, alongside the maintenance and calibration of the detector.

Performing the Alarm Test

The alarm test gas level reading can be increased or decreased in increments of 5% of the sensor scale, up to 100% of the sensor scale.

1. Enter the Product Settings and Configuration menu by pressing and holding the MENU button for 6 seconds. The alarm test screen appears.

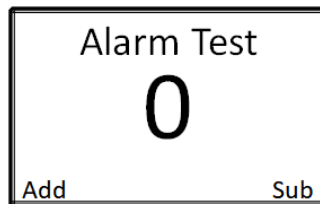

2. Press the ADD button until the Alarm 1 and Alarm 2 levels are reached and the relay(s) are triggered to light all visual alarm(s) and sound all audio alarm(s) on the controller.
3. Once all relays have been tested and the test is complete, press the SUB button to return the alarm test reading back to zero and to deactivate the controller alarm(s).
4. Use the MENU button to scroll through the rest of the Product Settings and Configuration menu and return to Normal Operating Mode.

Network ID

The Network ID is used to synchronize the communication between a wireless controller and the AirLink VOC Pro:

- There are 52 networks available with the GEN II 900 MHz radio.
- There are 78 networks available with the GEN II 2.4 GHz radio.

The controller and AirLink VOC Pro must have the same Network ID in order to communicate.

NOTE: Radio connections between AirLink sensors and monitors must either all be routed through a repeater or all go straight to the monitor.

1. If necessary, enter the Product Settings and Configuration menu by pressing and holding the MENU button for 6 seconds.
2. Press and release the MENU button until the Network ID screen appears.

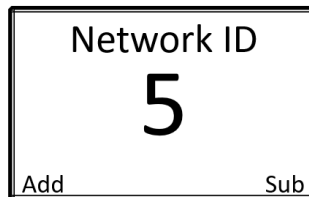

3. Press the ADD or SUB button until the Network ID matches the value being used on the Primary Monitor.
4. Use the MENU button to scroll through the rest of the Product Settings and Configuration menu and return to Normal Operating Mode.

System Information

The system information screen allows the end-user to view the following information:

- The status of the radio link
- The scale of the sensor element.
- The supply voltage of the sensor unit.
- The voltage value (in volts) that the sensor was reading when zeroed.
- The current voltage value (in volts) that the sensor element is reading.

This screen is for informational purposes only.

1. If necessary, enter the Product Settings and Configuration menu by pressing and holding the MENU button for 6 seconds.
2. Press and release the MENU button until the System Information screen appears.

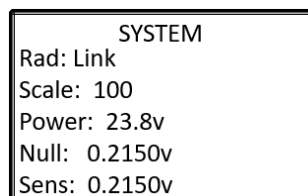

3. Review the information displayed.
4. Use the MENU button to scroll through the rest of the Product Settings and Configuration menu and return to Normal Operating Mode.

Zero/Calibration Timer Information

The zero/calibration time information screen allows the end-user to view the following information:

- The days since the sensor assembly was last zeroed.
- The days since the sensor assembly was last calibrated.
- The calibration number of the sensor, used for diagnostic purposes.

This screen is for informational purposes only.

NOTE: The Cal field automatically updates after an Auto Cal. When performing a Manual Cal, the gas reading must be adjusted by at least one button press to get the Cal field to update.

1. If necessary, enter the Product Settings and Configuration menu by pressing and holding the MENU button for 6 seconds.
2. Press and release the MENU button until the Zero/Calibration Timer Information screen appears.

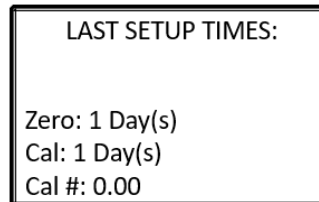

3. Review the information displayed.
4. Use the MENU button to scroll through the rest of the Product Settings and Configuration menu and return to Normal Operating Mode.

Unit Information

The unit information screen allows the end-user to view the following information:

- The number of missed radio transmissions to the controller
- The date of manufacture of the sensor assembly.
- The serial number of the sensor assembly.

This screen is for informational purposes only.

1. If necessary, enter the Product Settings and Configuration menu by pressing and holding the MENU button for 6 seconds.

2. Press and release the MENU button until the Unit Information screen appears.



3. Review the information displayed.
4. Use the MENU button to scroll through the rest of the Product Settings and Configuration menu and return to Normal Operating Mode.

Background Setting

The background setting is the gas reading at which the radio transmission changes from once every minute to once every five seconds. The background setting is adjustable so that if there is a consistent level of gas always present the sensor will not increase the radio transmission rate.

The default background level is 4% of the sensor element scale.

The minimum that the background can be set to is 1% of the sensor element scale.

The maximum that the background can be set to is 10% of the sensor element scale.

1. If necessary, enter the Product Settings and Configuration menu by pressing and holding the MENU button for 6 seconds.
2. Press and release the MENU button until the Background screen appears.

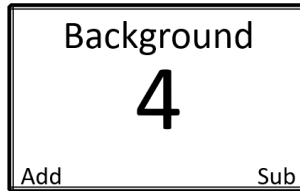

3. Press the ADD or SUB button until the Background is set to the desired level.
4. Use the MENU button to scroll through the rest of the Product Settings and Configuration menu and return to Normal Operating Mode.

Latching and Auto Resetting Relay Settings

Relay 1 and Relay 2 can be set to latching or auto resetting. Relays set to auto resetting will automatically deactivate when the detected gas level falls below the corresponding alarm setting. Conversely, latching relays, once activated, **MUST** be manually reset at the device, regardless of the change in gas detection level readings.

The factory default settings for Relay 1 and Relay 2 are auto resetting. During installation and setup, Relay 1 and Relay 2 are commonly customized as the following:

Table 6: Common Relay 1 and Relay 2 Settings

Relay	Alarm Setting	Latching/Auto Reset
Relay 1	Alarm 1	Auto Reset

Table 6: Common Relay 1 and Relay 2 Settings

Relay 2	Alarm 2	Latching
---------	---------	----------

Relay 1: Latching/Auto Reset Setting

1. If necessary, enter the Product Settings and Configuration menu by pressing and holding the MENU button for 6 seconds.
2. Press and release the MENU button until the Relay 1 Latching/Auto Resetting screen appears.

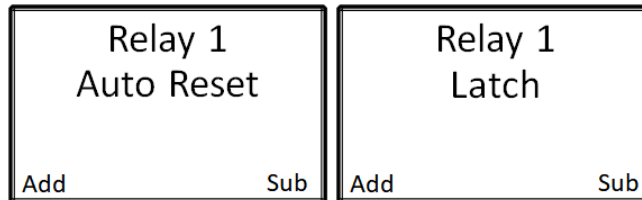

3. Use the ADD and SUB buttons to toggle between the “Auto Reset” and “Latch” options.
4. Press the MENU button to select the desired setting and to advance to the Relay 2 latching/ auto reset setting screen.

NOTE: For auto resetting alarms, the alarms will NOT deactivate until the gas level reading at the sensor has fallen 10% below the alarm set-point. For latching alarms, the gas level reading MUST be below the alarm set-point before the alarm can be deactivated. The alarms will NOT activate, even in the presence of gas, until you have exited the menu mode for approximately 1 minute.

Relay 2: Latching/Auto Reset Setting

1. If necessary, enter the Product Settings and Configuration menu by pressing and holding the MENU button for 6 seconds.
2. Press and release the MENU button until the Relay 2 Latching/Auto Reset screen appears.

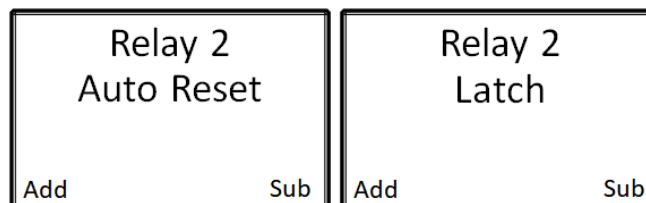

3. Use the ADD and SUB buttons to toggle between the “Auto Reset” and “Latch” options.
4. Use the MENU button to scroll through the rest of the Product Settings and Configuration menu and return to Normal Operating Mode.

Relay Fail-Safe Setting

From a safety perspective, any unknown situation must be considered potentially hazardous. When a stand-alone gas detector is unable to detect gas, an unknown condition is created and precautions must be taken to prevent personal injury or loss of life. This means that the device must be able to alert the end-user that it is no longer fully operational. This safety function is made possible by the fault terminal. For more information about the fault terminal and for instructions on how to wire your device, refer to the Connecting the Fault Terminal section of this manual.

Site specific circumstances may prevent the use of the fault terminal, leading to potentially dangerous situations without end-user notification. In response, the AirLink VOC Pro provides a relay fail-safe setting to enhance the safety protection provided when the fault terminal cannot be used.

The relay fail-safe setting reverses the behavior of the relays and allows a deactivated relay to serve as a warning of a potentially hazardous event. In fail-safe mode, the relays are activated upon device start-up and deactivated during alarm conditions and when the device is turned off. Some device failures, such as loss of power and firmware corruption, will also deactivate the relay.

NOTE: For maximum safety, the fault terminal **MUST** be used. A fail-safe relay will **NOT** notify the user of all potential device failures. The fail-safe setting should **ONLY** be enabled to provide enhanced safety protection when the fault terminal **CANNOT** be used.

The factory default settings on the AirLink VOC Pro for Relay 1 and Relay 2 fail-safe are No (Off).

If the fault terminal cannot be used, RKI Instruments recommends one of the following configurations:

Table 7: Recommended Configurations for Relay Fail-Safe Setting

Power Source	Relay Wiring	Fail-Safe	Outcome
External Power Supply	Normally-Closed (NC)	Yes (On)	Normal Operation: Open Alarm Activation: Closed
External Power Supply	Normally-Open (NO)	Yes (On)	Normal Operation: Closed Alarm Activation: Open

Relay 1: Fail-Safe Setting

1. If necessary, enter the Product Settings and Configuration menu by pressing and holding the MENU button for 6 seconds.
2. Press and release the MENU button until the Relay 1 Failsafe screen appears.

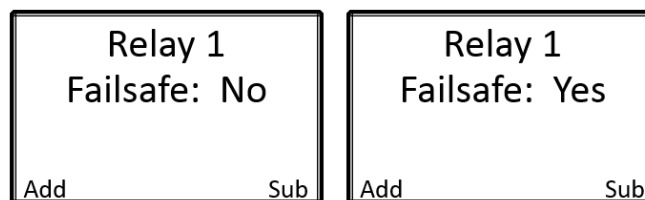

3. Use the ADD and SUB buttons to select the desired fail-safe setting for Relay 1. Select “Yes” to turn the fail-safe setting on, or select “No” to leave the fail-safe setting off.
4. Press the MENU button to select the desired setting and to advance to the Relay 2 fail-safe setting screen.

Relay 2: Fail-Safe Setting

1. If necessary, enter the Product Settings and Configuration menu by pressing and holding the MENU button for 6 seconds.
2. Press and release the MENU button until the Relay 2 Failsafe screen appears.

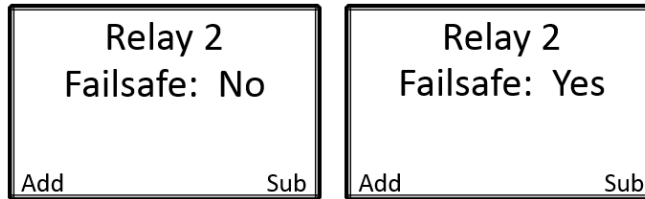

3. Use the ADD and SUB buttons to select the desired fail-safe setting for Relay 2. Select “Yes” to turn the fail-safe setting on, or select “No” to leave the fail-safe setting off.
4. Use the MENU button to scroll through the rest of the Product Settings and Configuration menu and return to Normal Operating Mode.

Fault Terminal Fail-Safe Setting

The Fault Terminal Fail-Safe status behavior can be adjusted to either activate during a fault condition or deactivate during a fault condition. The default setting is to deactivate during a fault condition, this setting should only be adjusted if the opposite behavior is desired.

Fault Terminal: Fail-Safe Setting

1. If necessary, enter the Product Settings and Configuration menu by pressing and holding the MENU button for 6 seconds.
2. Press and release the MENU button until the Fault Terminal Failsafe screen appears.

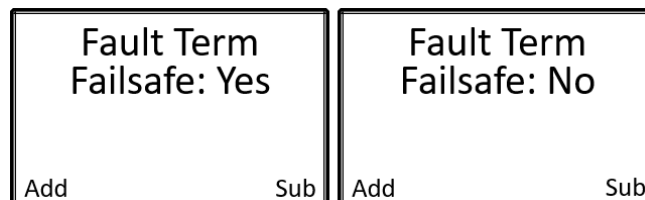

3. Use the ADD and SUB buttons to select the desired fail-safe setting for the Fault Terminal. Select “Yes” to turn the fail-safe setting on, or select “No” to turn the fail-safe setting off.
4. Use the MENU button to scroll through the rest of the Product Settings and Configuration menu and return to Normal Operating Mode.

Calibration Method

The calibration method selection allows you to choose how you calibrate the sensor element.

Manual Calibration (factory setting): Use the ADD and SUB buttons during calibration to match the reading shown on the screen to the value of the gas being applied.

Auto Calibration: Sets the reading, after a predetermined amount of time, during calibration to the value entered during the auto calibration setup process.

1. If necessary, enter the Product Settings and Configuration menu by pressing and holding the MENU button for 6 seconds.
2. Press and release the MENU button until the Cal Method screen appears.

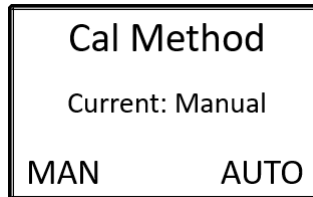

3. Use the ADD button to select manual calibration and the SUB button to select auto calibration.
4. Use the MENU button to scroll through the rest of the Product Settings and Configuration menu and return to Normal Operating Mode.

Modbus Address Setting

Modbus is the leading industrial open control protocol. Modbus is available in several different types, depending upon the media over which it is transmitted. Like most communication protocols, Modbus uses a master/client type behavior. The master sends a poll request for information to the client, the client decodes the request, and then sends a response with the requested data back to the master.

A Modbus message includes a Modbus address, commonly referred to as a unit ID. The Modbus address is used to identify the server address in RS-485 networks. Each server is assigned an address and listens for messages which contain this number in the Modbus address field.

The AirLink VOC Pro uses the original Modbus RTU over the RS-485 link. RS-485 Modbus has 255 addresses, ranging from 1 to 255. Eight of the addresses are used for internal system settings, leaving addresses 1 to 247 available for your device.

The RS-485 Modbus communication parameters used in the AirLink VOC Pro is 8 data bits, no parity, and 1 stop bit; these parameters are fixed and cannot be changed. The floating point data values are presented with the least significant bytes first.

When using Modbus over a RS-485 network, the communication parameters **MUST** be set correctly for all devices. For multiple devices using Modbus, ensure that no two units are assigned the same address. A duplication of addresses could cause errors in the transmission of data. Modbus addresses can be assigned sequentially or another appropriate address scheme for the specific network setup.

The factory default setting on the AirLink VOC Pro for the Modbus address setting is 1.

1. If necessary, enter the Product Settings and Configuration menu by pressing and holding the MENU button for 6 seconds.
2. Press and release the MENU button until the Modbus Address screen appears.

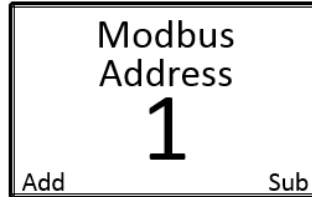

3. Use the ADD and SUB buttons to increase and decrease the Modbus address number, respectively.
4. Use the MENU button to scroll through the rest of the Product Settings and Configuration menu and return to Normal Operating Mode.

Modbus Baud Setting

The baud rate is the speed of data transmitted within the Modbus system, measured in bits per second (bps). For successful communication, the baud rate setting of the AirLink VOC Pro **MUST** match the baud rate setting on the connected controller or other Modbus device.

The AirLink VOC Pro's default Modbus baud setting is 9600 bps. The RS-485 Modbus communication parameters used in the AirLink VOC Pro are 8 data bits, no parity bit, and 1 stop bit (8-N-1) these parameters are fixed and cannot be changed. Some devices come with different Modbus baud rates. Check with your system administrator to determine if a different Modbus baud setting is needed for your system.

The pre-set Modbus baud setting available for the AirLink VOC Pro are the following:

- 110 bps
 - 300 bps
 - 1200 bps
 - 2400 bps
 - 4800 bps
 - 9600 bps
 - 19200 bps
1. If necessary, enter the Product Settings and Configuration menu by pressing and holding the MENU button for 6 seconds.

2. Press and release the MENU button until the Modbus Baud screen appears.

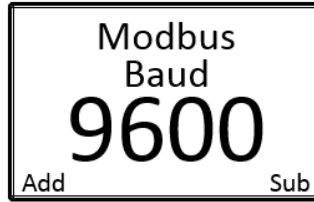

3. Use the ADD and SUB buttons to scroll through the available Modbus baud options.
4. Use the MENU button to scroll through the rest of the Product Settings and Configuration menu and return to Normal Operating Mode.

4-20 mA Offset Settings

Setting the 4-20 mA offset allows the end-user to calibrate the sensor's analog output. Upon installation of the device, if the detected gas reading on AirLink VOC Pro does not correspond to the reading on the controller, the zero offset (4 mA) and the full-scale offset (20 mA) can be adjusted on the unit.

Over time, as electronic components suffer from normal wear and tear, the circuits will tend to drift. This drift can cause variances in the amount of current output by the sensor, or in the current measurement by the controller. If at any time the reading on the AirLink VOC Pro no longer matches the reading on the controller, the 4-20 mA offset will need to be recalibrated.

The factory default settings on the AirLink VOC Pro for the 4-20 mA offset are 4.00 mA for the zero offset and 20.00 mA for the full-scale offset.

1. If necessary, enter the Product Settings and Configuration menu by pressing and holding the MENU button for 6 seconds.
2. Press and release the MENU button until the 4-20 mA Offset screen appears.

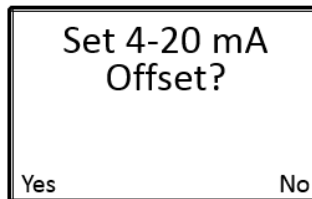

3. Press and release the ADD button to set the 4-20 mA offset and advance to the zero offset setting screen. If you do not wish to set the 4-20 mA offset, press and release the SUB or MENU button to advance to the display screen contrast setting screen.

Zero Offset Setting

If “Yes” is selected to set the 4-20 mA offset:

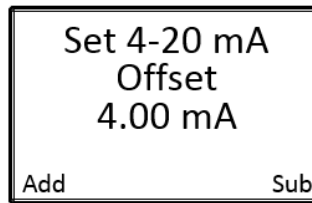

1. Use the ADD and SUB buttons to increase and decrease the zero offset on the unit, respectively, until the controller reads 0 %/PPM, depending on the gas type being detected.
2. Press the MENU button to save the desired setting and to advance to the full-scale offset setting screen.

Full-Scale Offset Setting

NOTE: Adjusting the full-scale offset will initiate alarm conditions. Disable the alarms or make sure all personnel are aware that any alarms are false.

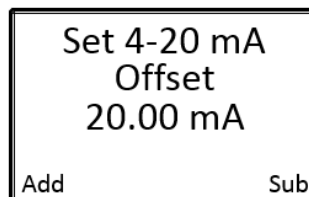

1. Use the ADD and SUB buttons to increase and decrease the full-scale offset, respectively, until the controller reads the full scale value for that channel.
2. Press the MENU button to save the desired setting and to advance to the display screen contrast setting screen.

Display Screen Contrast Setting

The display screen contrast is the difference in luminance or color that makes the displayed images distinguishable. Due to varying external elements, such as extreme sunlight, the brightness of the display screen may need to be adjusted for optimum viewing.

The factory default setting on the AirLink VOC Pro for the display screen contrast is 29, approximately 45% of the contrast scale. The contrast setting ranges from 1 to 64.

NOTE: Setting the contrast too low will cause the display image to become faint or indistinguishable, especially when the unit is located in areas with full-sun. The resulting field of view could be misinterpreted as an error within the device. Be sure to verify that the selected contract is within an appropriate range of viewing.

1. If necessary, enter the Product Settings and Configuration menu by pressing and holding the MENU button for 6 seconds.

2. Press and release the MENU button until the Contrast screen appears.



3. Use the ADD and SUB buttons to brighten and dim the contrast, respectively.
4. Use the MENU button to scroll through the rest of the Product Settings and Configuration menu and return to Normal Operating Mode.

Return to Factory Default Settings

Returning the AirLink VOC Pro to its factory default settings will reset all customization of the device, including the zero and calibration settings of the sensor element. A factory default does not change the gas type.

Table 8: AirLink VOC Pro Product and Configuration Factory Default Settings

Configuration	Setting
Network ID	5
Zero/Calibration Timer	*Cleared*
Background Setting	4
Relay 1: Latching/Auto Reset	Auto Reset
Relay 2: Latching/Auto Reset	Auto Reset
Relay 1: Fail-Safe Setting	No (Off)
Relay 2: Fail-Safe Setting	No (Off)

Table 9: AirLink VOC Pro Operation Factory Default Settings

Calibration Method	Manual
RS-485 Modbus Address Setting	1
RS-485 Modbus Baud Setting	9600 bps
4-20 mA Zero Offset Setting	4.00 mA
4-20 mA Full-Scale Offset Setting	20.00 mA
Sensor Element Zero	*Cleared*
Sensor Element Calibration	*Cleared*
Sensor Assembly Alarm 1 Setting	10% of Sensor Scale
Sensor Assembly Alarm 1 Increasing/Decreasing Setting	Increasing
Sensor Assembly Alarm 2 Setting	15% of Sensor Scale
Sensor Assembly Alarm 2 Increasing/Decreasing Setting	Increasing

1. If necessary, enter the Product Settings and Configuration menu by pressing and holding the MENU button for 6 seconds.
2. Press and release the MENU button until the Return to Factory Default screen appears.

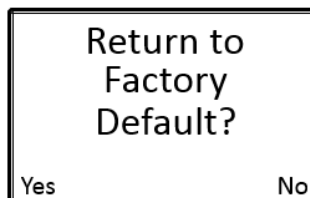

3. Press the ADD button to return the device to its factory default settings and to advance to the return to factory default settings confirmation screen. If you do not wish to return the device to its factory default settings, press the SUB or MENU button to continue to the Reset Zero & Cal Only screen.
4. If “Yes” is selected to return the device to its factory default settings:

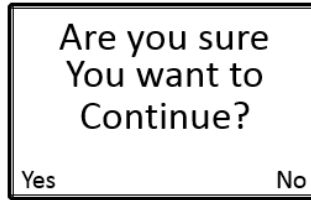

5. Press the ADD button to select “Yes” to confirm that you want to reset the device to its factory default settings and to return the device to normal operating mode. If you do not wish to continue to return the device to its factory default settings, press the SUB button to select “No” to continue to the Reset Zero & Cal Only screen.
6. Use the MENU button to scroll through the rest of the Product Settings and Configuration menu and return to Normal Operating Mode.

NOTE: If the AirLink VOC Pro is reset to the factory default settings, ALL configuration steps MUST be repeated and the device MUST then be zeroed and calibrated for proper operation of the device.

Reset Zero & Calibration Values

Resetting the zero and calibration settings of the sensor element will allow the currently stored zero and calibration values to be rest without having to reconfigure all of the other operational settings like with the Return to Factory Defaults option.

1. If necessary, enter the Product Settings and Configuration menu by pressing and holding the MENU button for 6 seconds.
2. Press and release the MENU button until the Reset Zero & Calibration Values screen appears.

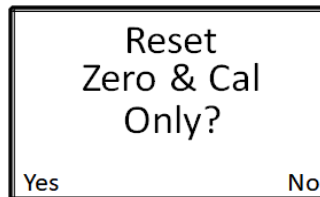

3. Press the ADD button to select “Yes” to reset the Zero and Calibration values and to advance to the Reset Zero & Cal Only confirmation screen. If you do not wish to reset the zero and calibration values, press the SUB button to select “No” to leave the Product Settings and Configuration menu and to return the device to normal operating mode.

4. If “Yes” is selected to reset the zero and calibration values:

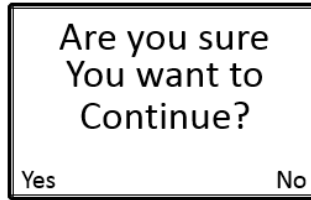

5. Press the ADD button to select “Yes” to confirm that you want to reset the Zero and Calibration values and to return the device to normal operating mode. If you do not wish to continue to reset the Zero and Calibration values, press the SUB button to select “No” to leave the Product Settings and Configuration menu and to return the device to normal operating mode.
6. Press and release the MENU button to return to Normal Operating Mode.

NOTE: If the AirLink VOC Pro’s stored Zero and Calibration values are reset, the device **MUST** be zeroed and calibrated for proper and safe operation of the device.

Operation Settings and Calibration

The Operation Settings menu allows you to:

- perform a zero adjust
- perform a span adjust
- change sensor alarm settings
- change sensor radio address

NOTE: After 5 minutes of no interaction with the device, the unit will automatically return to normal operating mode.

NOTE: The alarms will NOT activate, even in the presence of gas, until you have been out of the Operation Settings menu for 1 minute.

The AirLink VOC Pro continues monitoring for gas while in the Operation Settings menu.

Zeroing the Sensor

The first step of calibration is zeroing. The zeroing process **MUST** be performed in known clean air, with no contaminants or hazardous gasses present. If air quality cannot be guaranteed, a cylinder of zero air will be required to properly zero the sensor.

Materials

- 0.5 LPM fixed flow regulator with knob
- calibration cup
- calibration tubing
- zero air cylinder (if not in a fresh air environment)

Procedure

1. While the product is in normal operating mode, press the MENU button to activate the Operation Settings menu.

Zero
Press
ADD
to auto zero.

2. Press the ADD button to begin the zero process and advance to the clean air confirmation screen.

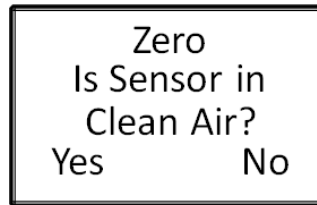

3. If the sensor is in clean air, press the ADD button to select “Yes” and continue to Step 5.
4. If the sensor is not in clear air:
 - a. Install the calibration cup to the AirLink VOC Pro’s sensor housing.
 - b. Screw the regulator into the zero air calibration cylinder.
 - c. Use the sample tubing to connect the regulator to the calibration cup.
 - d. Turn the regulator knob counterclockwise to open the regulator.
 - e. Allow the gas to flow for 1 minute.
 - f. Press the ADD button to select “Yes” and continue to Step 5.
5. The unit will automatically begin the 6-second zero process. During the zero, the display will show a countdown of the time remaining until the process is complete.

NOTE: The zero process cannot be stopped without disconnecting the power from the unit.

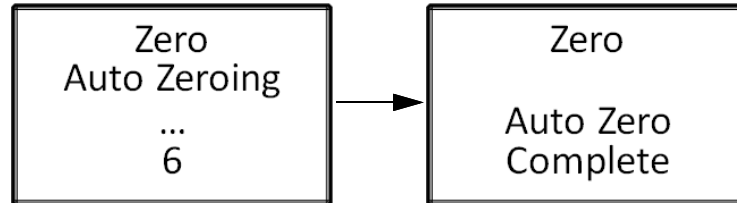

6. When the zero process is complete, press the MENU button to advance to the calibration screen.
7. If a zero air calibration cylinder was used, turn the regulator knob clockwise to close the regulator.

Calibrating the Sensor (Manual Cal)

You should ONLY calibrate the sensor after completing the zero process.

Either the Manual Cal screen or the Auto Cal screen appear, depending on how Calibration Method is set in the Product Settings and Configuration Menu (see page 39).

Calibration Frequency

A calibration should be performed EVERY thirty (30) days. Days since the last calibration should NEVER exceed ninety (90) days. RKI recommends that you calibrate your device regularly to ensure proper functionality and a safe work environment.

Materials

- 0.5 LPM fixed flow regulator with knob
- calibration cup
- calibration tubing
- calibration cylinder; RKI recommends using 50% of the full scale value of your detected gas

NOTE: For 10.6 eV and 11.7 eV PID sensors, if you want to calibrate with a gas other than isobutylene, you will have to take the calibration gas' factor to isobutylene into account when setting the calibration gas concentration.

Procedure

1. If you followed the instructions in Zeroing the Sensor, the screen below is displayed.
If you are accessing Manual Cal from Normal Operating Mode, press MENU twice.

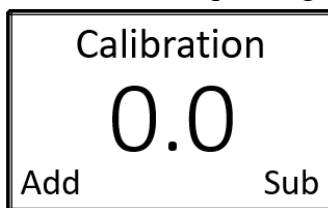

2. Unscrew and remove the sensor housing cap from the assembly.
3. Install the calibration cup to the AirLink VOC Pro's sensor housing.
4. Screw the regulator into the calibration cylinder.
5. Use the sample tubing to connect the regulator to the calibration cup.
6. Turn the regulator knob counterclockwise to open the regulator.
7. Let the gas flow until the reading stabilizes, approximately 1 minute.

8. Use the ADD and SUB buttons to adjust the reading on the screen to match the applied calibration gas concentration.

NOTE: For 10.6 eV and 11.7 eV PID sensors, if you are calibrating with a gas other than isobutylene, you must take the calibration gas' factor to isobutylene into account when setting the calibration gas concentration.

NOTE: Even if the reading does not need adjustment to match the calibration cylinder's concentration, you must adjust it up and then back down to reset the Cal field in the Zero/Calibration Timer Information screen.

9. When calibration is complete, remove the calibration cup from the sensor housing.
10. Press the MENU button to scroll to the Alarm Settings screen. See page 53 for Alarm Settings instructions.

Calibrating the Sensor (Auto Cal)

You should ONLY perform the calibration of the sensor after the zero process has been completed.

Either the Manual Cal screen or the Auto Cal screen appear, depending on how Calibration Method is set in the Product Settings and Configuration Menu (see page 39).

Calibration Frequency

A calibration should be performed EVERY thirty (30) days. Days since the last calibration should NEVER exceed ninety (90) days. RKI recommends that you calibrate your device regularly to ensure proper functionality and a safe work environment.

Materials

- 0.5 LPM fixed flow regulator with knob
- calibration cup
- calibration tubing
- calibration cylinder; RKI recommends using 50% of the full scale value of your detected gas

NOTE: For 10.6 eV and 11.7 eV PID sensors, if you want to calibrate with a gas other than isobutylene, you will have to take the calibration gas' factor to isobutylene into account when setting the calibration gas concentration.

Procedure

1. If you followed the instructions in Zeroing the Sensor, the screen below is displayed.
If you are accessing Auto Cal from Normal Operating Mode, press MENU twice.

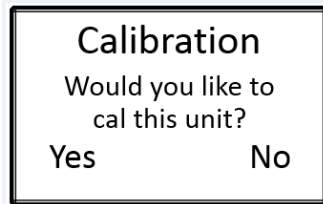

2. Press the ADD button to select "Yes" to begin the calibration process and to advance to the calibration confirmation screen. If you do not wish to calibrate the sensor, press the SUB button to select "No" to advance to the sensor radio address setting screen.

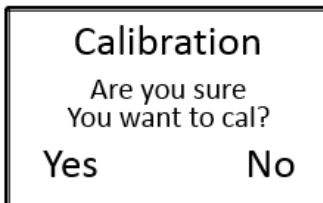

3. Press the ADD button to select "Yes" to confirm that you want to calibrate the sensor and to continue to the concentration setting screen. If you do not wish to continue to calibrate the sensor, press the SUB button to select "No" to advance to the sensor radio address setting screen.

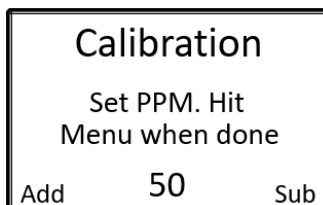

4. Use the ADD and SUB buttons to adjust the concentration to the calibration gas being used.

NOTE: For 10.6 eV and 11.7 eV PID sensors, if you are calibrating with a gas other than isobutylene, you must take the calibration gas' factor to isobutylene into account when setting the calibration gas concentration.

5. Press the MENU button to save the gas concentration setting and to advance to the calibration start screen.
6. Install the calibration cup to the AirLink VOC Pro's sensor housing.
7. Screw the regulator into the zero air calibration cylinder.
8. Use the sample tubing to connect the regulator to the calibration cup.

9. Turn the regulator knob counterclockwise to open the regulator.

Calibration
Apply gas then
hit menu button

10. Press the MENU button to begin calibrating the sensor. The unit automatically begins the calibration process. During calibration, the display shows a countdown of the time remaining until the process is complete. The amount of time varies based on the gas type.

Calibration
It will be caled
At the end of timer
120

NOTE: Once the calibration countdown has started, the process cannot be stopped without disconnecting the power from the unit.

11. When calibration is complete, remove the calibration cup from the sensor housing.

Calibration
Unit is now caled
to 50 PPM.
Reading: 50

NOTE: If the sensor responds extremely slow, or does not respond to the applied gas, it may indicate a failed sensor element. The sensor element will need to be replaced before completing the zero and calibration process.

12. Turn the regulator knob clockwise to close the regulator.
13. Press the MENU button to scroll to the Alarm Settings screen.

Sensor Alarm Settings

The AirLink VOC Pro has two alarm settings: Alarm 1 and Alarm 2. Regardless of whether the device includes the optional two dry-contact relays, the system alarm settings are available on the device. All alarm set-points are field adjustable from the lowest increment up to 70% of the full scale gas concentration. The Alarm 1 set-point should NEVER be programmed to a higher setting than the Alarm 2 set-point.

Both alarms are configurable to activate on either an increasing or decreasing level of gas. The factory default setting is to activate when the detected gas increases above the alarm set-point.

When the gas concentration detected at the sensor meets or exceeds the Alarm 1 set-point, the Alarm 1 indicator LED will illuminate amber. When the gas level meets or exceeds the Alarm 2 set-point, the Alarm 2 indicator LED will illuminate red. The alarm indicator LEDs will not switch off until the gas level reading at the sensor has fallen 10% below the alarm set-points or until the alarm is manually reset at the device, dependent upon the relay latching/auto reset settings.

If the device includes the optional two dry-contact relays, Relay 1 and Relay 2, the Alarm 1 and Alarm 2 settings will control the wired relays, respectively. When external alarming devices, such as alarm lights (visual) and horns (audio) are wired to the device, as the alarm set-points are reached, the relays will become activated as they are wired and programmed to perform.

Sensor Alarm 1 Setting

1. From normal operating mode, press and release MENU until the Alarm 1 setting screen appears.

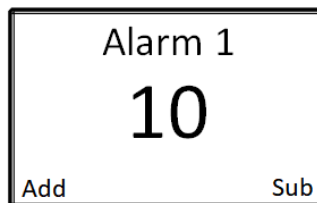

2. Use the ADD and SUB buttons to increase and decrease the Alarm 1 set-point, respectively.
3. Press the MENU button to save the desired setting and to advance to the sensor Alarm 1 increasing/decreasing setting screen.

Sensor Alarm 1 Increasing/Decreasing Setting

1. From normal operating mode, press and release MENU until the Alarm 1 increasing/decreasing setting screen appears.



2. Use the ADD and SUB buttons to select between activation on an Increasing or Decreasing gas level, respectively.

3. Press the MENU button to save the desired setting and to advance to the sensor Alarm 2 setting screen.

Sensor Alarm 2 Setting

1. From normal operating mode, press and release MENU until the Alarm 2 setting screen appears.

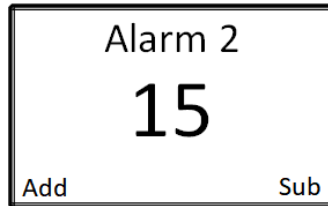

2. Use the ADD and SUB buttons to increase and decrease the Alarm 2 set-point, respectively.
3. Press the MENU button to save the desired setting and to advance to the sensor Alarm 2 increasing/decreasing setting screen.

Sensor Alarm 2 Increasing/Decreasing Setting

1. From normal operating mode, press and release MENU until the Alarm 2 increasing/decreasing setting screen appears.

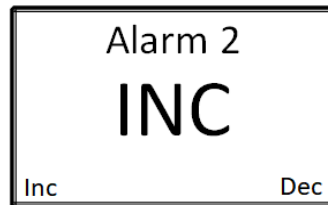

2. Use the ADD and SUB buttons to select between activation on an Increasing or Decreasing gas level, respectively.
3. Use the MENU button to scroll through the rest of the Operation Settings menu and return to Normal Operating Mode.

NOTE: The alarms will NOT activate, even in the presence of gas, until you have been out of the Operation Settings menu for 1 minute. For auto resetting alarms, the alarms will NOT deactivate until the gas level reading at the sensor has fallen 10% below the alarm set-point.

Sensor Radio Address

The AirLink VOC Pro radio address is adjustable from 1 to 255, each sensor assembly on the network needs a unique radio address in order to avoid a fault at the controller. The default radio address is 1.

1. From normal operating mode, press and release MENU until the sensor radio address screen appears.

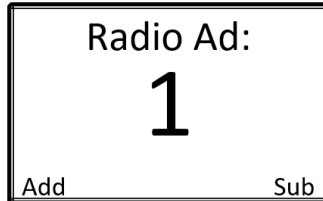

2. Use the ADD and SUB buttons to increase and decrease the sensor radio address, respectively.
3. Press the MENU button to return to Normal Operating Mode.

NOTE: The alarms will NOT activate, even in the presence of gas, until you have been out of the Operation Settings menu for 1 minute. For auto resetting alarms, the alarms will NOT deactivate until the gas level reading at the sensor has fallen 10% below the alarm set-point.

Maintenance

RKI recommends that our equipment be calibrated a MINIMUM of every 90 days, and STRONGLY advise that calibration be performed every 30 days. Without knowing the specific application, sensor assembly location, gas exposure and other factors, the company recommends monthly calibrations – assuming no damage or potential damage has occurred to the sensor and that there has not been a power outage to the sensor assembly. If damage has occurred or the power supplied to the sensor has changed, a calibration should be completed immediately.

Scheduled maintenance should include the zero and calibration of the sensor and an alarm test. See page 47 and page 32 for instructions to perform these procedures.

The sensor head should be kept free of airborne particles, dirt, mud, spider webs, bugs and insects, and/or any other debris that could potentially cover or coat the sensor. Keeping the sensor head clear of foreign articles will allow for proper operation of the device. A brief inspection during scheduled maintenance should suffice, but dependent upon the location and the environment in which the unit is installed, more frequent inspections may be warranted.

The AirLink VOC Pro may be adversely affected by the exposure to certain airborne substances. Loss of sensitivity or corrosion may be gradual, if such materials are present in sufficient concentrations. The performance of the device may be impaired during operation in the presence of substances that can cause corrosion on gold plating. Continuous and high concentrations of corrosive gases may also have a detrimental long-term effect on the product's service life. The presence of such substances in an area does not preclude the use of this device, but the likelihood of the shortened lifetime of the sensor element, as a result, should be noted. Use of the AirLink VOC Pro in these environments may require more frequently scheduled maintenance to ensure safe and reliable system performance.

Troubleshooting

The troubleshooting guide describes symptoms, probable causes, and recommended action for problems you may encounter with the AirLink VOC Pro.

NOTE: This troubleshooting guide describes AirLink VOC Pro problems only. See the controller operator's manual for problems you may encounter with the controller.

Table 10: AirLink VOC Pro Fault Codes

Problem	Cause(s)	Solution(s)
F1 Check Sensor Cable	The control board has lost communication with the digital sensor interface adapter board.	1. Check connection between the sensor housing connector header and the digital sensor interface adapter board plug-in. 2. Replace the sensor interface adapter board
F4 Check Sensor Board	The control board has lost communication with the sensor interface board.	1. Replace the sensor interface board.

Table 10: AirLink VOC Pro Fault Codes

Problem	Cause(s)	Solution(s)
F5 Try to Zero Again	The unit did not zero correctly, due to: <ul style="list-style-type: none"> • the presence of gas, • a sensor error, or • a sensor interface board error. 	<ol style="list-style-type: none"> 1. Re-zero the device in clear air. 2. Replace the sensor element. 3. Replace the sensor interface board.
F6 Try to Calibrate Again	The unit did not calibrate correctly, due to: <ul style="list-style-type: none"> • the absence of gas, • no radio connection to controller, • a sensor error, or • a sensor interface board error. 	<ol style="list-style-type: none"> 1. Recalibrate the sensor element and verify that gas is present during calibration. 2. Ensure the AirLink VOC Pro has a radio connection to a controller. 3. Replace the sensor element. 4. Replace the sensor interface board.
F14 Check Radio	The sensor assembly has lost communication with the Primary Monitor due to: <ul style="list-style-type: none"> • Network ID is incorrectly configured. • Sensor assembly is obstructed/too far from the Primary Monitor. • Radio module is not working in the sensor assembly 	<ol style="list-style-type: none"> 1. Check that the Network ID on the sensor assembly matched the Primary Monitor Network ID 2. Move the sensor assembly away from the obstruction or use a high gain antenna. 3. Replace sensor radio module.
* <i>System faults will activate the fault terminal on the device.</i>		

Replacing the Desiccant

WARNING: Do not remove the sensor housing cap or enclosure lid while the circuits are energized unless the area is determined to be non-hazardous. Keep the sensor housing cap and enclosure lid tightly closed during operation.

Each AirLink VOC Pro comes with a desiccant bag installed in the junction box. The contents are blue when it is dry. As the desiccant absorbs moisture, it turns amber. Periodically check the desiccant and replace it if it has turned amber.

Cleaning the 10.0 eV or 10.6 eV PID Lamp

WARNING: Do not remove the sensor housing cap or enclosure lid while the circuits are energized unless the area is determined to be non-hazardous. Keep the sensor housing cap and enclosure lid tightly closed during operation.

CAUTION: The internal components can be static sensitive. Use caution when opening the enclosure and handling internal components. DO NOT use any metal objects or tools to remove the sensor.

Clean the 10.0 eV or 10.6 eV lamp if you notice a significant drop in sensitivity from one scheduled calibration to another or if you are not able to calibrate the detector.

11.7 eV lamps should not be cleaned because of their susceptibility to moisture.

Cleaning Kit

The lamp cleaning kits for the 10.0 eV and 10.6 eV lamps include:

- an electrode stack removal tool
- a small vial of aluminum oxide powder
- 40 cotton swabs
- 10 finger cots

Lamp Cleaning Procedure

1. Press and hold the SUB button for approximately 6 seconds, until “OFF” shows on the display screen.
2. Unscrew and remove the sensor housing cap from the sensor housing base. Set aside.

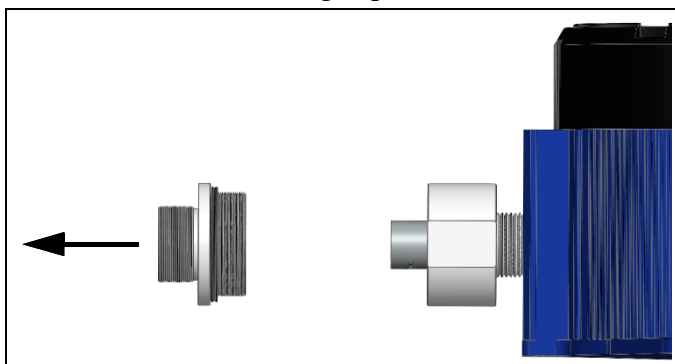

3. Gently unplug the sensor element from the sensor housing board.

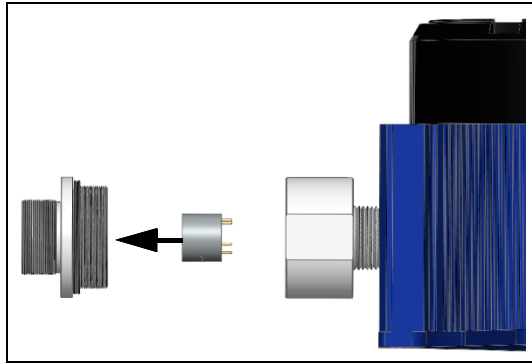

4. Place the PID sensor face down on a flat clean working surface.
5. Do not touch the lamp window with your fingers as this may contaminate the window with finger oil. At this point it is recommended that the finger cots be used on the fingers handling the lamp. Finger cots are included with the lamp cleaning kit.
6. Hold the PID sensor steady on the working surface with one hand and using the other hand, locate the tabs on the electrode stack removal tool and insert them into the slots on the side of the PID sensor near the face.



Figure 10: Using Removal Tool

7. Squeeze the removal tool to push the tabs into the sensor slots until the electrode stack and lamp are released.
8. Carefully lift the PID sensor body away from the electrode stack and lamp. Take care not to touch the lamp window, the flat end of the lamp, with your fingers. If the lamp remains lodged in the sensor body, carefully remove it with tweezers.

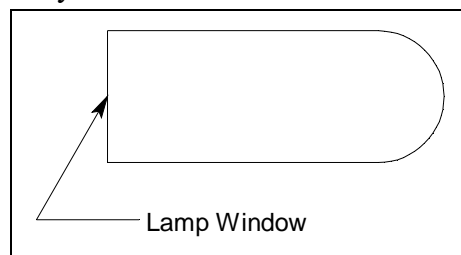

Figure 11: Lamp Window Location

9. If the spring in the lamp cavity comes out, place it back into the lamp cavity.

10. Hold the lamp in one hand being careful not to touch the lamp window with your fingers.
11. With the other hand collect a small amount of aluminum oxide powder on a cotton swab.
12. Use this cotton swab to polish the PID lamp window. Use a circular motion, applying light pressure to clean the lamp window. Do not touch the lamp window with your fingers.

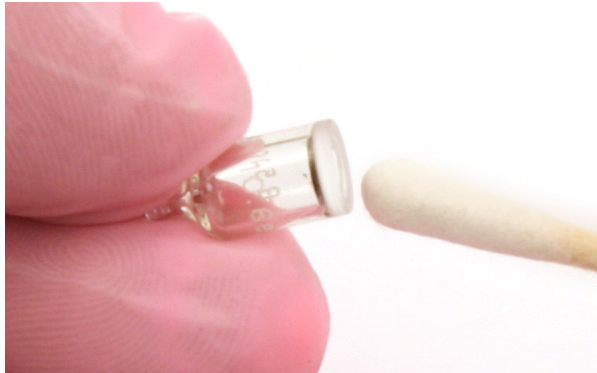

Figure 12: Polishing the Electrode Lamp Window

13. Continue polishing until you can hear a squeaking sound made by the cotton swab moving over the window surface. This usually occurs after about 15 seconds of polishing.
14. Remove the residual powder from the lamp window with a clean cotton swab. Take care not to touch the tip of the cotton swab that is used to clean the lamp as this may contaminate it with finger oil.
15. Ensure the lamp is completely dry and any visible signs of contamination are removed before reinstalling.
16. Hold the electrode stack between the thumb and forefinger of one hand and place the window end of the lamp inside the O-ring seal in the electrode stack with the other hand as shown below.

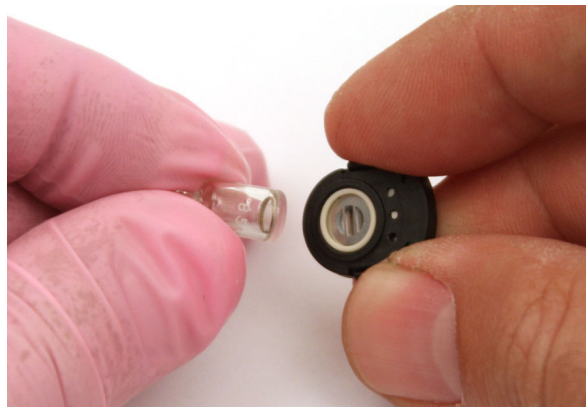
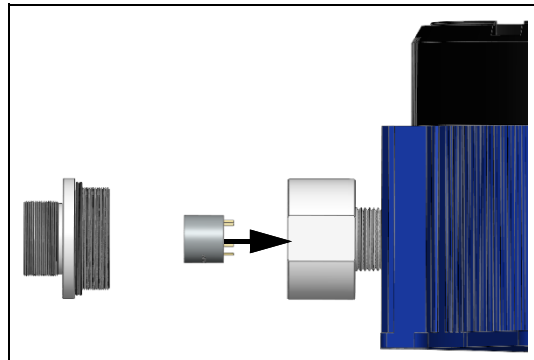

Figure 13: Reinstalling the Electrode Lamp

17. Twisting the lamp slightly during insertion will help to ensure the lamp window is snug against the stack's front electrode. The lamp should be supported by the O-ring.
18. Continuing to hold the electrode stack between your forefinger and thumb, carefully insert the lamp into the lamp cavity in the sensor ensuring that the lamp remains in position.

19. Press in the electrode stack firmly to ensure that the stack wing clips are engaged and the faces of the stack and sensor body are flush.
20. Plug the sensor element into the sensor housing board. Ensure that the pins on the sensing element align with the sockets on the sensor housing board.



21. Screw the sensor housing cap back onto the sensor housing base, ensuring that the sensor housing cap is only tightened hand tight.

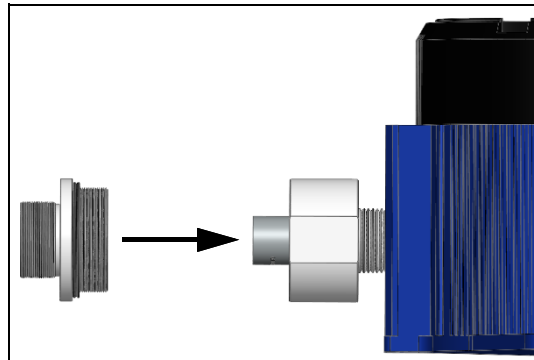

22. Press the ADD button to turn the AirLink VOC Pro on.
23. Wait 10 minutes and then zero and calibrate the detector as described on page 47.

Replacing the PID Lamp

WARNING: *Do not remove the sensor housing cap or enclosure lid while the circuits are energized unless the area is determined to be non-hazardous. Keep the sensor housing cap and enclosure lid tightly closed during operation.*

CAUTION: *The internal components can be static sensitive. Use caution when opening the enclosure and handling internal components. DO NOT use any metal objects or tools to remove the sensor.*

If cleaning the PID lamp does not resolve any calibration problems you may be having, the lamp may need to be replaced.

Ordering the Correct Replacement Lamp

It's important to order the correct replacement lamp for your PID sensor.

1. Look at the part number label on the side of your PID sensor.
2. See the table below for replacement lamp part numbers based on your sensor's part number.

Table 11: PID Sensor Replacement Lamp Part Number

Sensor Part Number	Replacement Lamp Part Number
61-0302	51-1503
61-0303	
61-0304	
61-0305	51-1504

Lamp Replacement Procedure

NOTE: Do not touch the new lamp window (the flat end) with your fingers as this may contaminate the window with finger oil.

1. Press and hold the SUB button for approximately 6 seconds, until "OFF" shows on the display screen.

2. Unscrew and remove the sensor housing cap from the sensor housing base. Set aside.

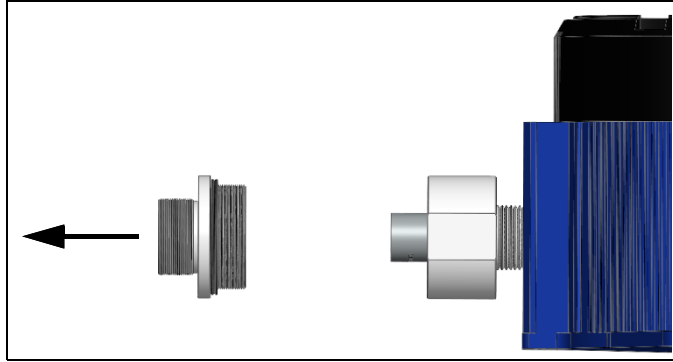

3. Gently unplug the sensor element from the sensor housing board.

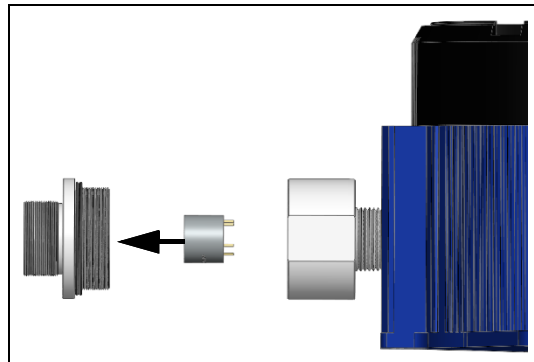

4. Place the PID sensor face down on a flat clean working surface.
5. Hold the PID sensor steady on the working surface with one hand and using the other hand, locate the tabs on the electrode stack removal tool and insert them into the slots on the side of the PID sensor near the face.



Figure 14: Using Removal Tool

6. Squeeze the removal tool to push the tabs into the sensor slots until the electrode stack and lamp are released.
7. Carefully lift the PID sensor body away from the electrode stack and lamp. If the lamp remains lodged in the sensor body, carefully remove it with tweezers.
8. If the spring in the lamp cavity comes out, place it back into the lamp cavity.

9. Discard the old PID lamp.

NOTE: At this point it is recommended that the finger cots be used on the fingers handling the lamp. Finger cots are included with the lamp cleaning kit.

10. Hold the electrode stack between the thumb and forefinger of one hand and place the window end of the new lamp inside the O-ring seal in the electrode stack with the other hand as shown below. Take care not to touch the lamp window.

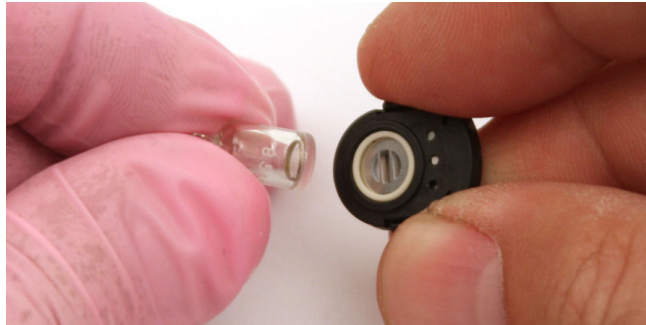
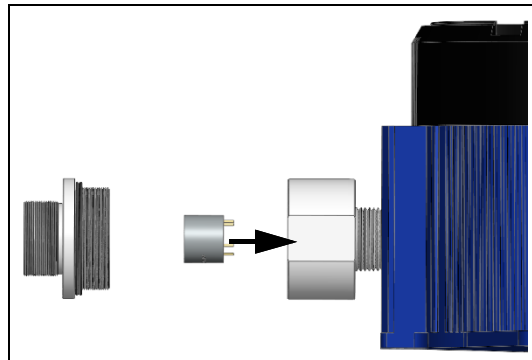
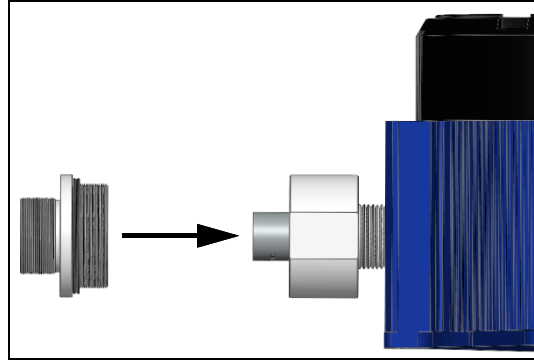

Figure 15: Reinstalling the Electrode Lamp

11. Twisting the lamp slightly during insertion will help to ensure the lamp window is snug against the stack's front electrode. The lamp should be supported by the O-ring.
12. Continuing to hold the electrode stack between your forefinger and thumb, carefully insert the lamp into the lamp cavity in the sensor ensuring that the lamp remains in position.
13. Press in the electrode stack firmly to ensure that the stack wing clips are engaged and the faces of the stack and sensor body are flush.
14. Plug the sensor element into the sensor housing board. Ensure that the pins on the sensing element align with the sockets on the sensor housing board.



15. Screw the sensor housing cap back onto the sensor housing base, ensuring that the sensor housing cap is only tightened hand tight.



16. Press the ADD button to turn the AirLink VOC Pro on.
17. Wait 10 minutes and then zero and calibrate the detector as described on page 47.

Replacing the PID Electrode Stack

WARNING: *Do not remove the sensor housing cap or enclosure lid while the circuits are energized unless the area is determined to be non-hazardous. Keep the sensor housing cap and enclosure lid tightly closed during operation.*

CAUTION: *The internal components can be static sensitive. Use caution when opening the enclosure and handling internal components. DO NOT use any metal objects or tools to remove the sensor.*

The electrode stack can last for the life of the PID sensor if the AirLink VOC Pro is used in a very clean, controlled environment. When used in a heavily contaminated or dirty environment, the electrode stack may only last a month. A contaminated electrode stack will cause a drop in sensitivity which can cause problems calibrating the PID channel. The electrode stack should be replaced if the PID sensor shows signs of contamination even after cleaning or replacing the lamp.

NOTE: Do not touch the new lamp window (the flat end) with your fingers as this may contaminate the window with finger oil.

1. Press and hold the SUB button for approximately 6 seconds, until “OFF” shows on the display screen.

2. Unscrew and remove the sensor housing cap from the sensor housing base. Set aside.

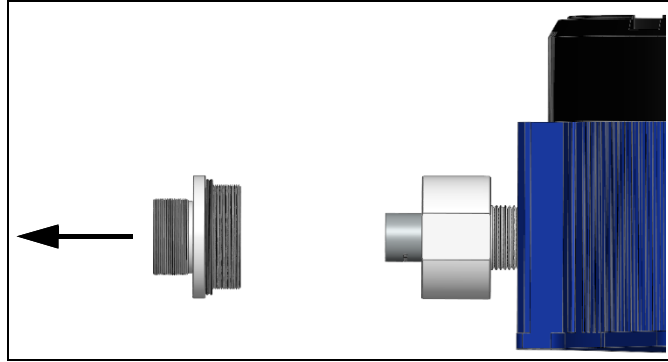

3. Gently unplug the sensor element from the sensor housing board.

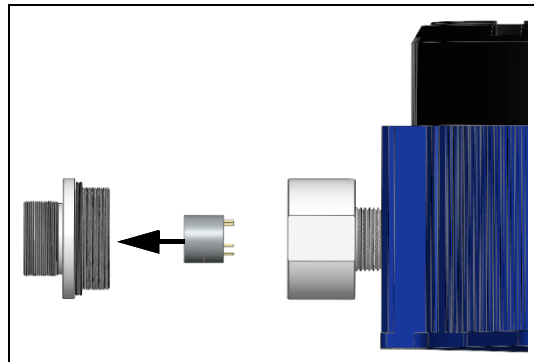

4. Place the PID sensor face down on a flat clean working surface.

NOTE: At this point it is recommended that the finger cots be used on the fingers handling the lamp. Finger cots are included with the lamp cleaning kit.

5. Hold the PID sensor steady on the working surface with one hand and using the other hand, locate the tabs on the electrode stack removal tool and insert them into the slots on the side of the PID sensor near the face.



Figure 16: Using Removal Tool

6. Squeeze the removal tool to push the tabs into the sensor slots until the electrode stack and lamp are released.
7. Carefully lift the PID sensor body away from the electrode stack and lamp. If the lamp remains lodged in the sensor body, carefully remove it with tweezers.

8. If the spring in the lamp cavity comes out, place it back into the lamp cavity.
9. Discard the old electrode stack.
10. Hold the new electrode stack between the thumb and forefinger of one hand and place the window end of the lamp inside the O-ring seal in the new electrode stack with the other hand as shown below. Take care not to touch the lamp window.

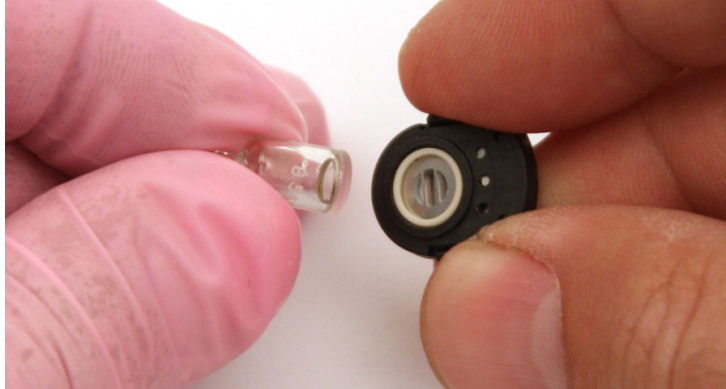
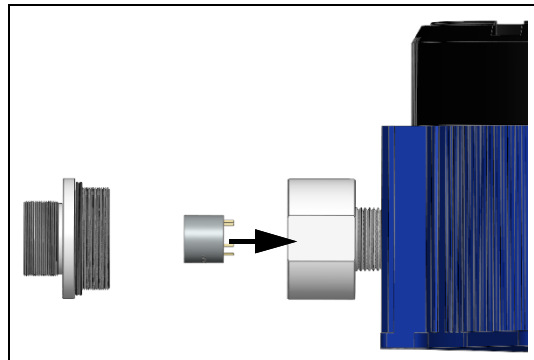
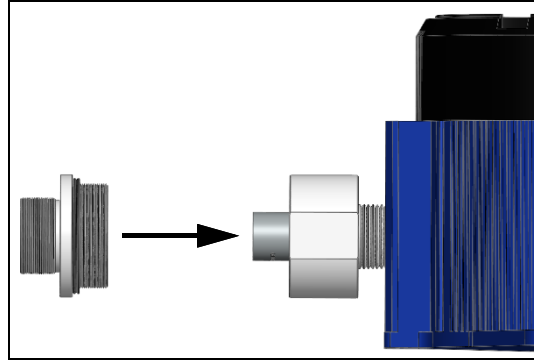

Figure 17: Reinstalling Electrode Lamp

11. Twisting the lamp slightly during insertion will help to ensure the lamp window is snug against the stack's front electrode. The lamp should be supported by the O-ring.
12. Continuing to hold the electrode stack between your forefinger and thumb, carefully insert the lamp into the lamp cavity in the sensor ensuring that the lamp remains in position.
13. Press in the electrode stack firmly to ensure that the stack wing clips are engaged and the faces of the stack and sensor body are flush.
14. Plug the sensor element into the sensor housing board. Ensure that the pins on the sensing element align with the sockets on the sensor housing board.



15. Screw the sensor housing cap back onto the sensor housing base, ensuring that the sensor housing cap is only tightened hand tight.



16. Press the ADD button to turn the AirLink VOC Pro on.
17. Wait 10 minutes and then zero and calibrate the detector as described on page 47.

Replacing the Sensor

RKI recommends replacing the sensor element whenever a slow response to gas is observed during the normal calibration process. After replacing the sensor element, the device **MUST** be zeroed and calibrated for proper operation of the device.

WARNING: *Do not remove the sensor housing cap or enclosure lid while the circuits are energized unless the area is determined to be non-hazardous. Keep the sensor housing cap and enclosure lid tightly closed during operation.*

CAUTION: *The internal components can be static sensitive. Use caution when opening the enclosure and handling internal components. DO NOT use any metal objects or tools to remove the sensor.*

1. Press and hold the SUB button for approximately 6 seconds, until “OFF” shows on the display screen.
2. Unscrew and remove the sensor housing cap from the sensor housing base. Set aside.

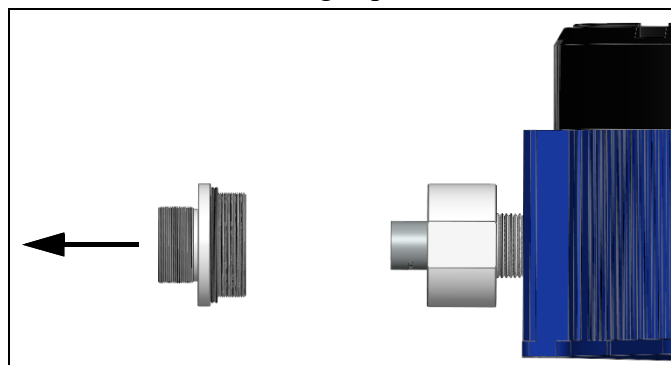

3. Gently unplug the sensor element from the sensor housing board.

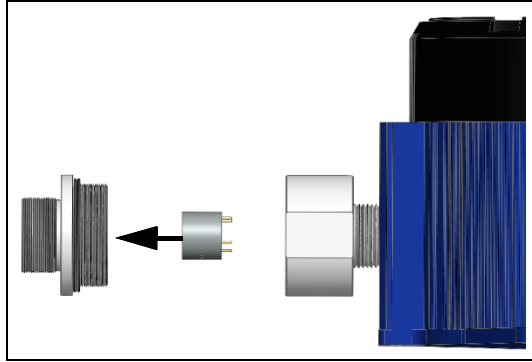

4. Plug the new sensor element into the sensor housing board. Ensure that the pins on the sensing element align with the sockets on the sensor housing board.

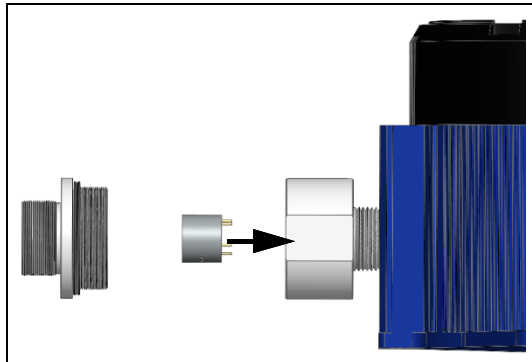

5. Screw the sensor housing cap back onto the sensor housing base, ensuring that the sensor housing cap is only tightened hand tight.

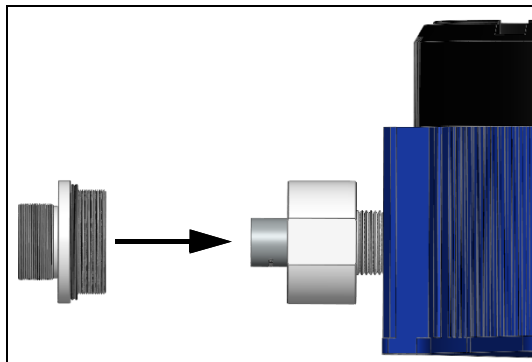

6. Press the ADD button to turn the AirLink VOC Pro on.
7. Wait 10 minutes and then zero and calibrate the detector as described on page 47.

Replacing the Fuse

WARNING: Do not remove the sensor housing cap or enclosure lid while the circuits are energized unless the area is determined to be non-hazardous. Keep the sensor housing cap and enclosure lid tightly closed during operation.

CAUTION: The internal components can be static sensitive. Use caution when opening the enclosure and handling internal components. DO NOT use any metal objects or tools to remove the fuses.

1. Disconnect or turn off power to the VOC Pro.
2. Unscrew the enclosure lid and set it aside.
3. Grab the thumbscrews and gently lift the internal system out of the enclosure. It can rest on the edge of the enclosure.

NOTE: Disconnecting the sensor connector plug from the sensor housing will allow for the complete removal of the internal system from the device enclosure. Disconnecting the internal system may provide ease in accessing the control board terminals for wiring. Reconnect the sensor connector plug before reinstalling the internal system.

4. Locate the fuse that needs to be replaced.

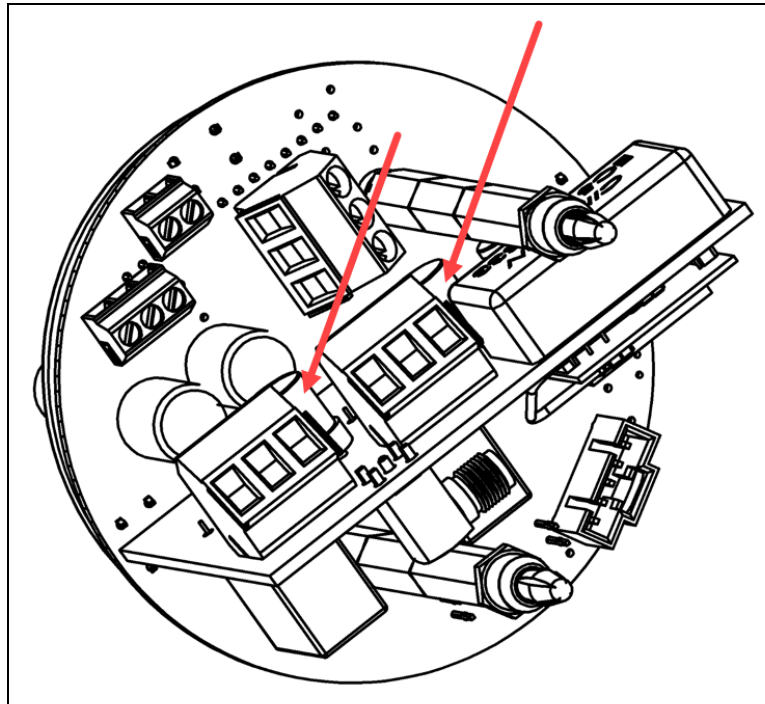

5. Pull the old fuse straight out.
6. Align the pins on the replacement fuse with the sockets in the fuse holder.

7. Push the new fuse into the fuse holder.
8. Place the internal system back into the enclosure, matching each mounting post to its corresponding eyelet anchored within the base of the enclosure.
9. Using the thumbscrews, gently push to seat the internal system into the mounting posts.

NOTE: The thumbscrews on the VOC Pro function **ONLY** as thumb-holds for ease in removal of the internal system from the base of the enclosure. Do **NOT** attempt to loosen or tighten the thumbscrews when opening or closing the enclosure.

10. Verify that the sealing ring, seated at the threaded opening of the device enclosure, is correctly in place.
11. Secure the enclosure lid back onto the enclosure.

WARNING: *When securing the lid onto the device, tighten the enclosure lid by hand ONLY. Overtightening of the lid by use of hand-tools could result in damage to the O-ring, potentially compromising the moisture seal, resulting in an unsafe environment.*

Parts List

Table 12 lists replacement parts and accessories for the AirLink VOC Pro.

Table 12: Parts List

Part Number	Description
09-0300RK	Desiccant bag
33-0560RK	PID sensor electrode stack, low range 10.6 eV sensor, 2 stacks
33-0560-01	PID sensor electrode stack, low range 10.6 eV sensor, 1 stack
33-0562	PID sensor electrode stack, high range 10.6 eV sensor
33-0563	PID sensor electrode stack, 10.0 eV sensor
33-0564	PID sensor electrode stack, 11.7 eV sensor
43-4163	Fuse, 4A
47-5110-5-XX	Cable with connector for remote-mounted kit (specify length in 1-foot increments, up to 35 feet, when ordering), 5-pin
47-5111-XX	Cable with connectors for remote-mounted antenna (specify length when ordering: choices are 5, 10, 15, 25, 50, 75, 100 ft)
49-1619-01	Single battery with connector (need 2 if replacing both batteries)
51-1503	PID sensor replacement lamp, for 10.0 eV, low range 10.6 eV, and high range 10.6 eV sensors
51-1504	PID sensor replacement lamp, 11.7 eV sensor
61-0302	10.6 eV low range replacement sensor, with lamp and stack
61-0303	10.6 eV high range replacement sensor, with lamp and stack
61-0304	11.7 eV replacement sensor, with lamp and stack
61-0305	10.0 eV replacement sensor, with lamp and stack
61-2001	Remote sensor mounting kit, 5-pin explosion-proof
71-0535	AirLink VOC Pro Operator's Manual (this document)
81-0076RK	Zero air calibration cylinder, 17 liter
81-0076RK-01	Zero air calibration cylinder, 34 liter steel
81-0076RK-03	Zero air calibration cylinder, 103 liter
81-0100RK-04	Calibration cylinder, 5 ppm benzene in air, 34 liter aluminum
81-0103RK-04	Calibration cylinder, 100 ppm isobutylene in air, 34 liter aluminum
81-0104RK-04	Calibration cylinder, 10 ppm isobutylene in air, 34 liter aluminum

Table 12: Parts List

Part Number	Description
81-1050RK	Regulator with gauge and knob, 0.5 LPM, for 17 liter and 34 liter steel calibration cylinders (cylinders with external threads)
81-1051RK	Regulator with gauge and knob, 0.5 LPM, for 34 liter aluminum, 58 liter, and 103 liter calibration cylinders (cylinders with internal threads)
81-1183	Calibration cup with 3 foot tube
82-0003RK	Electrode stack removal tool
82-0101RK	Magnetic wand
82-0300RK	Aluminum oxide powder PID lamp cleaning kit, with electrode stack removal tool, for 10.0 eV and 10.6 eV PID sensors' lamps ONLY
Z2000-CAPFILTER	Teflon filter for sensor housing assembly

Appendix A: 4-20 mA Signal

This appendix is only an introduction. The information should serve as a brief overview of 4-20 mA current loop signal ranges and should not be considered a complete reference for proper implementation or use.

Industry standards pertaining to 4-20 mA current loop signals and other aspects of electronics are assumed to be known by the technician. For proper connection to a controller or Programmable Logic Controller (PLC), refer to the manufacturer's specific manual or instructions for that device.

Overview

When using 4-20 mA wired output signal devices, the 4-20 mA defines the current loop analog signal range, with 4 mA representing the lowest end of the range and 20 mA the highest. The relationship between the current loop and the gas value is linear. In addition, the AirLink VOC Pro uses values below 4 mA to indicate special status conditions, as shown below:

Table 13: 4-20 mA Ranges

Current	Detector Status
2 mA	Sensor Fault
3 mA	Sensor in Menu Mode
3.5 mA	Sensor being Calibrated

The 4 mA allows the receiving controller/PLC to distinguish between a zero signal, a broken wire, or an unresponsive instrument. Benefits of 4-20 mA convention are that it is: an industry standard, low-cost to implement, can reject some forms of electrical noise, and the signal does not change value around the "loop" (as opposed to voltage). The key advantage of the current loop is that the accuracy of the signal is not affected by a potential voltage drop in the interconnected wiring. Even with significant resistance in the line, the current loop AirLink VOC Pro will maintain the proper current for the device, up to its maximum voltage capability.

Only one current level can be present at any time. Each device that operates via a 4-20 mA current loop signal must be wired directly to the controller. Units that are wired in a daisy chain configuration for the 4-20 mA current loop signal will not properly transmit data communications to the controller.

Calculations

$$I_{(4-20)} = \left(\frac{(16)(\text{value})}{\text{scale}} \right) + 4$$

$I_{(4-20)}$ = Current of loop, measured in mA

value = ppm (or %) of gas concentration

scale = full scale of sensor

Table 14: Sensor Element Scale Ranges

Sensor Type	Gas Type	Formula	Range
Photo Ionization Detector (PID)	Volatile Organic Compounds	VOC10	0-10 PPM
Photo Ionization Detector (PID)	Volatile Organic Compounds	VOC20	0-20 PPM
Photo Ionization Detector (PID)	Volatile Organic Compounds	VOC50	0-50 PPM
Photo Ionization Detector (PID)	Volatile Organic Compounds	VOC1K	0-1000 PPM
Photo Ionization Detector (PID)	Volatile Organic Compounds	VOC2K	0-2000 PPM

Actual ranges may vary with our product. For inquiries beyond the information and instructions provided, contact the sales representative of this product for assistance.

Measuring Current

If the value measured is 0 mA, then: the loop wires are broken, the sensor assembly is not powered up, the sensor assembly is malfunctioning, or the controller is malfunctioning. A digital multi-meter (DMM), or current meter, may be used in conjunction with the controller and/or to test the 4-20 mA current loop signal. To measure the current, place the meter probes in line with the current loop.

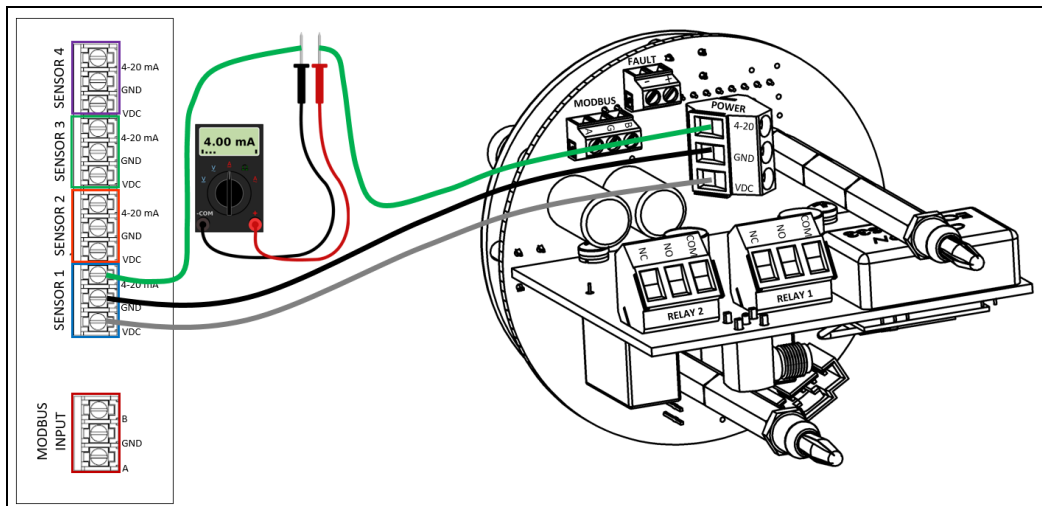

Appendix B: Modbus Communications

RKI controllers have the capability of accepting Modbus sensor inputs for data communications with AirLink VOC Pro series detectors. Modbus is a communication protocol that uses an RS-485 serial connection, and can accept a number of different devices.

Based on the type of circuit used, there is a limit on how many devices that can be connected to a Modbus sensor network. RKI controllers currently allow a maximum of 64 devices on a single network. The data is transferred along the Modbus network at a specified Modbus baud, or rate of speed. Though small, networks that have a high number of devices connected will incur a small, proportional delay in the communication transfer of data.

Wiring Configurations

A daisy chain is a wiring scheme in which multiple devices are wired together in a sequence, or in a ring. Daisy chains may be used for power, analog signals, digital data, or a combination thereof. For the purposes of the AirLink VOC Pro, the term daisy chain refers to multiple devices connected in a series to form a single long line of devices, connected via the wiring patterns embedded within each device.

Twisted pair cabling is a type of wiring in which two conductors of a single circuit are twisted together for the purposes of canceling out electromagnetic interference (EMI) from external sources as well as “crosstalk” between neighboring pairs. In electronics, crosstalk is any phenomenon by which a signal transmitted on one circuit or channel of a transmission system creates an undesired effect in another circuit or channel. The AirLink VOC Pro requires twisted pairs for all wired Modbus connections.

Twisted pair cables are often shielded in an attempt to further prevent EMI. Electromagnetic shielding provides an electric conductive barrier to attenuate electromagnetic waves external to the shield and provides a conduction path by which induced currents can be circulated and return to the source, via ground reference connection. These cables are referred to as shielded twisted pairs (STP) and are recommended for operation areas with high noise levels.

Proper Connection

The distance of the Modbus connection from the gas detection device to the controller cannot exceed 4,000 feet. In the instance of daisy-chained devices, this applies to the last sensor connected on the line. Connection distances of 100 feet, or less, require 22 to 24 gauge wire. Connection distances that range more than 100 feet require 18 to 20 gauge wire.

For more information on properly wiring a daisy chain network of devices for Modbus, consult the following diagram.

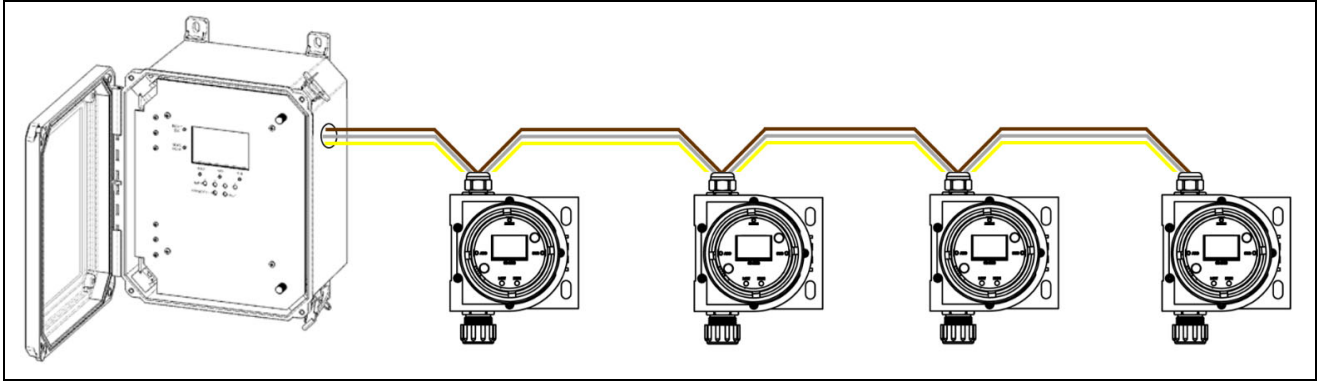

The signal wire of each unit is run to the signal terminal of the neighboring sensor. With each device connected to the previous device via the signal wire, a “chain” is created, with the first device in the chain directly connected to the controller.

Table 15: RS-485 Modbus Connection Distances for Electrical Wiring

Distance	Length	Gauge Size	Twisted Pairs
Short	< 100 Feet	22 to 24 Gauge	Shielded, in areas of high noise
Medium	101 Feet to 1,000 Feet	18 to 20 Gauge	Shielded, in areas of high noise
Long*	1,000 Feet to 4,000 Feet	18 to 20 Gauge	Shielded, in areas of high noise

(*) Terminating resistor may be required for the last device in the daisy-chain.

Appendix C: Modbus Register Map

Register Address (Hex)	Register Address (Dec)	Data Description	R/W	Length	Unit	Valid Response(s)
1	1	Gas Reading	R	2	FLOAT	Numerical Gas Reading
3	3	Modbus Address	R	1	UINT	0 – 247
4	4	Gas Type	R	1	ENUM	0 – 26, see below
5	5	Unit Type	R	1	ENUM	0 – 1, see below
6	6	Major Revision	R	1	UINT	0 – 100
7	7	Minor Revision	R	1	UINT	0 – 9
8	8	Mode of Sensor	R	1	ENUM	0 – 7, see below
9	9	Voltage Reading	R	2	FLOAT	12V – 35V
B	11	Fault Code	R	1	ENUM	0 – 6, see below
C	12	Sensor Type	R	1	ENUM	0-4, see below
E†	14†	Relay 1 Setting	R	2	FLOAT	1 – 32000
10†	16†	Relay 2 Setting	R	2	FLOAT	1 – 32000
16	22	Precision	R	1	INT	0 – 3
17†	23†	Relay Setting	R	1	BFLD	See Relay Setting Table
18	24	Days Since Last Zero	R	1	UINT	0 – 60000 (>60000) Default to “Never”
19	25	Calibration Type	R	1	ENUM	0 – 1
1A	26	Auto-Calibration Value	R	2	FLOAT	Numerical Gas Reading
1C	28	Days Since Last Calibration	R	1	UINT	0-60000 (>60000) Default to “Never”
1E	30	Relay 1 State	R	1	INT	0 – Relay Inactive 1 – Relay Active
1F	31	Relay 2 State	R	1	INT	0 – Relay Inactive 1 – Relay Active
20	32	Relay 1 Reset	R/W	1	INT	Read as 0 Write 1 to reset Relay 1 state
21	33	Relay 2 Reset	R/W	1	INT	Read as 0 Write 1 to reset Relay 2 state

- Register Address 1: Hexadecimal numbers
- Register Address 2: Decimal numbers
- R/W: Read/Write capable data
- R: Read-only data
- FLOAT: Floating point number
- ENUM: Enumeration
- UINT: Unsigned integer
- INT: Integer
- BFLD: Bit Field
- (*): Limited by precision

AirLink VOC Pro Modbus Register MAP Enumeration Keys

Register Address 4: Gas Type

Response	Gas Type
0	H2S – Hydrogen Sulfide
1	SO2 – Sulfur Dioxide
2	O2 – Oxygen
3	CO – Carbon Monoxide
4	CL2 – Chlorine
5	CO2 – Carbon Dioxide
6	LEL – Combustible Gas
7	VOC – Volatile Organic Compounds
9	HCL – Hydrogen Chloride
10	NH3 – Ammonia
12	CLO2 – Chlorine Dioxide
13	HCN – Hydrogen Cyanide
14	F2 - Fluorine
15	HF – Hydrogen Fluoride
16	CH2O - Formaldehyde
17	NO2 – Nitrogen Dioxide
18	O3 - Ozone
26	PH3 – Phosphine
27	HBr – Hydrogen Bromide
28	EtO – Ethylene Oxide
29	CH3SH – Methyl Mercaptan
30	AsH3 - Arsine

Register Address 5: Unit Type

Response	Unit Type
0	PPM
1	%

Register Address 8: Mode of Sensor

Response	Sensor Mode
0	Normal Operating Mode
1	Zero Mode
2	Calibration Mode
3	Alarm Test Mode
5	Diagnostic Mode
6	Advanced Mode
7	Administrator Mode

Register Address B/11: Fault Code

Response	Fault Type
0	No Fault
1	Loss of Communication with Sensor Board
4	Loss of Communication with Sensor Element/Housing
5	Zero Error
6	Calibration Error

Register Address C/12: Sensor Type

Response	Sensor Type
0	EC – Electrochemical
1	IR – Infrared
2	CB – Catalytic Bead
4	PID – Photo Ionization Detector

Register Address 17/23: Relay Setting

Bit	Relay Setting	Function
5	Relay 2: Increasing/ Decreasing Setting	0 – Decreasing
		1 - Increasing
4	Relay 1: Increasing/ Decreasing Setting	0 – Decreasing
		1 - Increasing
3	Relay 2: Failsafe Setting	0 – No (Off)
		1 – Yes (On)
2	Relay 1: Failsafe Setting	0 – No (Off)
		1 – Yes (On)
1	Relay 2: Latch/Auto Reset	0 – Auto Reset
		1 - Latch
0	Relay 1: Latch/Auto Reset	0 – Auto Reset
		1 – Latch

Register Address 19/25: Calibration Type

Response	Calibration Type
0	Manual Calibration
1	Auto Calibration